

2026

CATÁLOGO
DE PRODUCTOS

INTERNACIONAL
Argentina | Uruguay



WETZEL S.A.

Fundada en 1932 en Joinville/SC, Wetzel es una referencia en los segmentos en los que opera, reconocida por su capacidad para satisfacer demandas específicas y de alto nivel de exigencia.

Con una amplia y diversificada cartera, la empresa ofrece soluciones innovadoras y competitivas, desarrolladas en colaboración con sus clientes para garantizar el mejor rendimiento en proyectos de alta complejidad técnica.

Comprometida con la calidad y la excelencia, Wetzel realiza inversiones constantes en tecnología, procesos y personas, garantizando la eficiencia y la fiabilidad en cada etapa de la producción.

Dinámica y en constante evolución, la empresa mantiene una presencia consolidada en el mercado brasileño y una presencia creciente en el extranjero, reforzando su posición como referente en calidad, innovación y confianza.

UNIDAD DE NEGOCIOS

COMPONENTES PARA
INSTALACIONES **ELÉCTRICAS**
Y **ILUMINACIÓN INDUSTRIAL**

COMPONENTES
AUTOMOTRIZ EN
ALUMÍNIO



COMPONENTES PARA INSTALACIONES ELÉCTRICAS INDUSTRIALES

La Unidad Electrotécnica desarrolla y fabrica componentes para instalaciones eléctricas industriales, centrándose en los segmentos de gestión de cables, iluminación industrial y productos para áreas clasificadas.

Su cartera reúne soluciones completas para la gestión de cables, disponibles en aluminio y plástico, diseñadas con alta calidad, durabilidad y precisión dimensional.

En el área de iluminación industrial LED, Wetzel combina décadas de experiencia y liderazgo en el mercado para ofrecer una línea diversificada, capaz de satisfacer las exigencias de todos los sectores de la industria, desde la ligera hasta la pesada, garantizando eficiencia energética, robustez y fiabilidad.

Los productos para áreas clasificadas se desarrollan de acuerdo con las certificaciones técnicas más rigurosas, garantizando seguridad, rendimiento y conformidad en entornos con riesgo de explosión.

Con ingeniería especializada y procesos de producción de excelencia, Wetzel Electrotécnica se consolida como socio estratégico de la industria en la búsqueda de soluciones eléctricas seguras, duraderas y de alto rendimiento.

www.WETZEL.com.br

ÍNDICE

CAJA MÚLTIPLE POLIWETZEL



-  **6** Cuerpo
-  **7** Cuerpo y Tapón
-  **8** Caja Montada
-  **9** Conector Poliwetzel
-  **10** Tapas
-  **12** Tapón PVC
-  **12** Tapón Aluminio

CAJA MÚLTIPLE BASTIDOR

-  **14** Cuerpo
-  **15** Caja Montada
-  **16** Tapas

ACCESORIOS



-  **18** Conector Recto
-  **19** Empalme
-  **20** Conector Recto Box
-  **21** Conector Curvo Tipo Bolsa (Codo)
-  **21** Abrazadera Tipo Uña

-  **22** Arandela
-  **22** Boquilla
-  **23** Anillo de Estanqueidad Externo
-  **23** Anillo de Estanqueidad O-ring
-  **24** Junta de Vedación

CAJA DE PASO

-  **26** Sin Pintura
-  **28** Con Pintura

CAJA DE MÚLTIPLE REDONDA

-  **32** Diámetro Pequeño
-  **33** Diámetro Medio

CAJA DE DERIVACIÓN REFORZADA

-  **35** Con Pintura

CAJA DE PISO

-  **39** Modelo Baja
-  **40** Modelo Alta
-  **41** Anillo de Regulación

CAJA MÚLTIPLE

POLIWETZEL

PLATA - SIN PINTURA - CON PINTURA

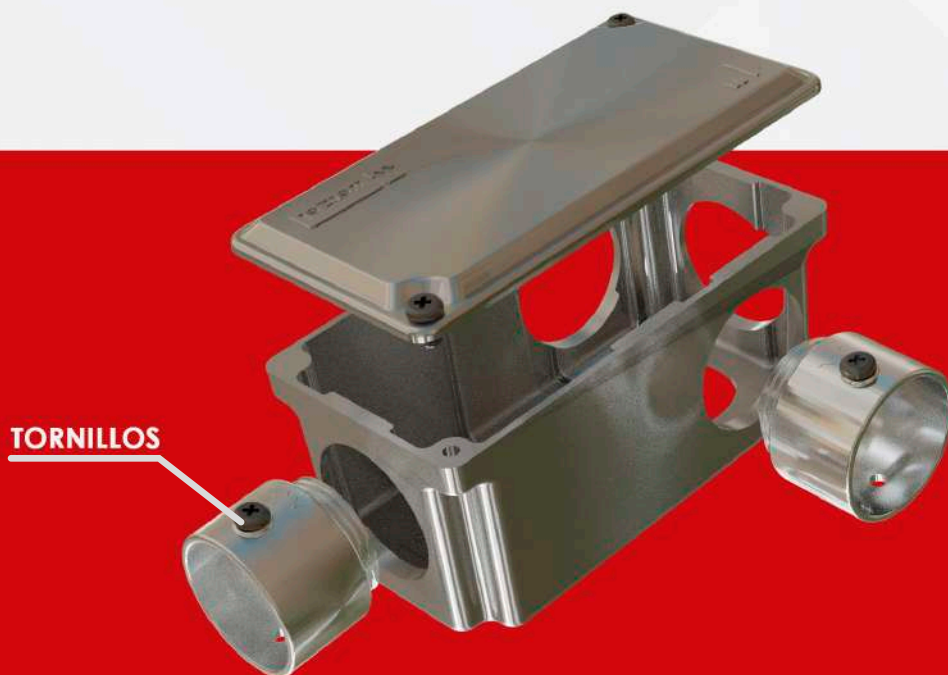

TORNILLOS

CONOZCA MÁS SOBRE

MODELOS

- DISPONIBLE EN MODELO L y X



L



X

DIFERENTE ALTURA EN EL CALIBRE 3/4"

- GARANTIZA MÁS VOLUMEN INTERNO;
- PRACTICIDAD EN LA INSTALACIÓN Y PASO DE CABLES, EVITANDO APLASTAMIENTOS Y REDUCIENDO RIESGOS DE CORTOCIRCUITOS ELÉCTRICOS;



OTROS



- CON TORNILLO PARA PUNTO DE ATERRAMIENTO



CON 2 PUNTOS DE FIJACIÓN



PLATA

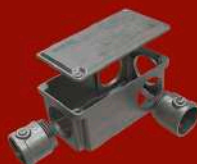

SIN PINTURA







CON PINTURA
GRISS MUNSEL 6.5







CAJA MÚLTIPLE POLIWETZEL - PLATA

CUERPO Y 1 TORNILLO PARA ATERRAMIENTO

	CÓDIGO	MODELO	CALIBRE ROSCA	CANT. EMB.	DIMENSIONES (mm)	A	B	C	D	E
	E002712031	L	1/2"	12		92,5	48	20	50,5	19
	E002712041	L	3/4"	12		92,5	48	20	50,5	19
	E002712051	L	1"	12		115	50	25	60	28,5
	E002812031	X	1/2"	12		92,5	48	20	50,5	-
	E002812041	X	3/4"	12		92,5	48	20	50,5	-
	E002812051	X	1"	12		115	50	25	60	-





CAJA MÚLTIPLE POLIWETZEL - SIN PINTURA

CUERPO Y 1 TORNILLO PARA ATERRAMIENTO

	CÓDIGO	MODELO	CALIBRE ROSCA	CANT. EMB.	DIMENSIONES (mm)	A	B	C	D	E
	E002512031	L	1/2"	12		92,5	48	20	50,5	19
	E002512041	L	3/4"	12		92,5	48	20	50,5	19
	E002512051	L	1"	12		115	50	25	60	28,5
	E002612031	X	1/2"	12		92,5	48	20	50,5	-
	E002612041	X	3/4"	12		92,5	48	20	50,5	-
	E002612051	X	1"	12		115	50	25	60	-

CAJA MÚLTIPLE POLIWETZEL - CON PINTURA

CUERPO Y 1 TORNILLO PARA ATERRAMIENTO

	CÓDIGO	MODELO	CALIBRE ROSCA	CANT. EMB.	DIMENSIONES (mm)	A	B	C	D	E
	E002312031	L	1/2"	12		92,5	48	20	50,5	19
	E002312041	L	3/4"	12		92,5	48	20	50,5	19
	E002312051	L	1"	12		115	50	25	60	28,5
	E002412031	X	1/2"	12		92,5	48	20	50,5	-
	E002412041	X	3/4"	12		92,5	48	20	50,5	-
	E002412051	X	1"	12		115	50	25	60	-

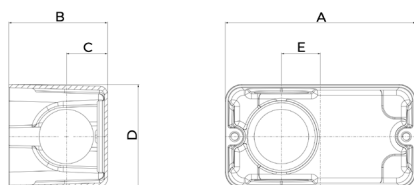



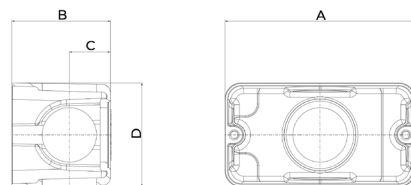

MODELO L



MODELO X





CAJA MÚLTIPLE POLIWETZEL - PLATA

CUERPO CON 3 TAPONES Y 1 TORNILLO PARA ATERRAMIENTO

	CÓDIGO	MODELO	CALIBRE ROSCA	CANT. EMB.	DIMENSIONES (mm)	A	B	C	D	E
	E002702031	L	1/2"	12		92,5	48	20	50,5	19
	E002702041	L	3/4"	12		92,5	48	20	50,5	19
	E002702051	L	1"	12		115	50	25	60	28,5
	E002820031	X	1/2"	12		92,5	48	20	50,5	-
	E0028202041	X	3/4"	12		92,5	48	20	50,5	-
	E0028202051	X	1"	12		115	50	25	60	-





CAJA MÚLTIPLE POLIWETZEL - SIN PINTURA

CUERPO CON 3 TAPONES Y 1 TORNILLO PARA ATERRAMIENTO

	CÓDIGO	MODELO	CALIBRE ROSCA	CANT. EMB.	DIMENSIONES (mm)	A	B	C	D	E
	E002502031	L	1/2"	12		92,5	48	20	50,5	19
	E002502041	L	3/4"	12		92,5	48	20	50,5	19
	E002502051	L	1"	12		115	50	25	60	28,5
	E002602031	X	1/2"	12		92,5	48	20	50,5	-
	E002602041	X	3/4"	12		92,5	48	20	50,5	-
	E002602051	X	1"	12		115	50	25	60	-

CAJA MÚLTIPLE POLIWETZEL - CON PINTURA

CUERPO CON 3 TAPONES Y 1 TORNILLO PARA ATERRAMIENTO

	CÓDIGO	MODELO	CALIBRE ROSCA	CANT. EMB.	DIMENSIONES (mm)	A	B	C	D	E
	E002302031	L	1/2"	12		92,5	48	20	50,5	19
	E002302041	L	3/4"	12		92,5	48	20	50,5	19
	E002302051	L	1"	12		115	50	25	60	28,5
	E002402031	X	1/2"	12		92,5	48	20	50,5	-
	E002402041	X	3/4"	12		92,5	48	20	50,5	-
	E002402051	X	1"	12		115	50	25	60	-

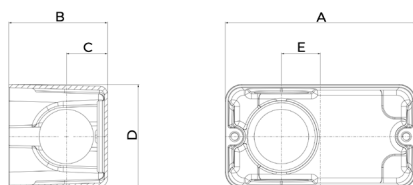



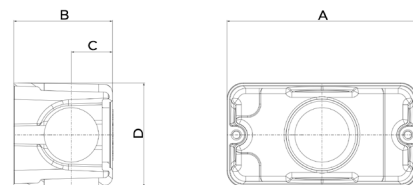



MODELO L



MODELO X

CAJA MÚLTIPLE POLIWETZEL - PLATA







CAJA, TAPA, 3 TAPONES, TORNILLOS PARA TAPA Y 1 TORNILLO PARA ATERRAMIENTO

	CÓDIGO	MODELO	CALIBRE ROSCA	CANT. EMB.	DIMENSIONES (mm)	A	B	C	D	E
	E002700034	L	1/2"	12		92,5	52,2	20	50,5	19
	E002700044	L	3/4"	12		92,5	52,2	20	50,5	19
	E002700054	L	1"	12		115	55	25	60	28,5
	E002700064	L	1.1/4"	12		143	76,5	32,5	80	31,5
	E002700074	L	2"	12		160	90,5	42,5	90	35
	E002800034	X	1/2"	12		92,5	52,2	20	50,5	-
	E002800044	X	3/4"	12		92,5	52,2	20	50,5	-
	E002800054	X	1"	12		115	55	25	60	-
	E002800064	X	1.1/4"	12		143	76,5	32,5	80	-
	E002800074	X	2"	12		160	90,5	42,5	90	-

* Acompaña tornillos en la tapa (2 en el 1/2", 3/4" y 1" y 4 en los demás) y 1 tornillo en la punto de aterramiento.

CAJA MÚLTIPLE POLIWETZEL - SIN PINTURA





CAJA, TAPA, 3 TAPONES, TORNILLOS PARA TAPA Y 1 TORNILLO PARA ATERRAMIENTO

	CÓDIGO	MODELO	CALIBRE ROSCA	CANT. EMB.	DIMENSIONES (mm)	A	B	C	D	E
	E002502030	L	1/2"	12		92,5	52,2	20	50,5	19
	E002502040	L	3/4"	12		92,5	52,2	20	50,5	19
	E002502050	L	1"	12		115	55	25	60	28,5
	E002502060	L	1.1/4"	12		143	76,5	32,5	80	31,5
	E002502070	L	2"	12		160	90,5	42,5	90	35
	E002602030	X	1/2"	12		92,5	52,2	20	50,5	-
	E002602040	X	3/4"	12		92,5	52,2	20	50,5	-
	E002602050	X	1"	12		115	55	25	60	-
	E002602060	X	1.1/4"	12		143	76,5	32,5	80	-
	E002602070	X	2"	12		160	90,5	42,5	90	-

* Acompaña tornillos en la tapa (2 en el 1/2", 3/4" y 1" y 4 en los demás) y 1 tornillo en la punto de aterramiento.

CAJA MÚLTIPLE POLIWETZEL - CON PINTURA

CAJA, TAPA, 3 TAPONES, TORNILLOS PARA TAPA Y 1 TORNILLO PARA ATERRAMIENTO

	CÓDIGO	MODELO	CALIBRE ROSCA	CANT. EMB.	DIMENSIONES (mm)	A	B	C	D	E
	E002302030	L	1/2"	12		92,5	52,2	20	50,5	19
	E002302040	L	3/4"	12		92,5	52,2	20	50,5	19
	E002302050	L	1"	12		115	55	25	60	28,5
	E002302060	L	1.1/4"	12		143	76,5	32,5	80	31,5
	E002302070	L	2"	12		160	90,5	42,5	90	35
	E002402030	X	1/2"	12		92,5	52,2	20	50,5	-
	E002402040	X	3/4"	12		92,5	52,2	20	50,5	-
	E002402050	X	1"	12		115	55	25	60	-
	E002402060	X	1.1/4"	12		143	76,5	32,5	80	-
	E002402070	X	2"	12		160	90,5	42,5	90	-

* Acompaña tornillos en la tapa (2 en el 1/2", 3/4" y 1" y 4 en los demás) y 1 tornillo en la punto de aterramiento.

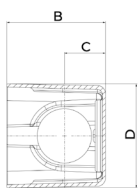

MODELO L

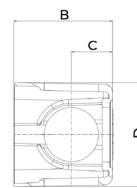
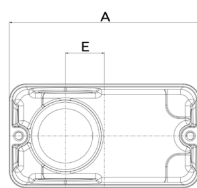



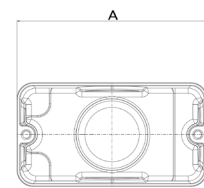

MODELO X







CONECTOR CORTO PARA CAJA MÚLTIPLE - PLATA

CON ROSCA

	CÓDIGO	CALIBRE ROSCA	CALIBRE TUBO	CANT. EMB.	DIMENSIONES (mm)	A	B	C	D	E	F
	E001702030	1/2"	3/4"	30		24	5	24	20,1	17,4	14,3
	E001702040	3/4"	1"	30		26	5	33,8	28,4	18,2	20
	E001702050	1"	1.1/4"	20		28,5	6	39	33,2	22,2	25,4
	E001702060	1.1/4"	1.1/2"	10		32	6	49	43,3	24	34,5
	E001702070	2"	2"	10		43	8,2	57	51,7	32,5	38,5





CONECTOR CORTO PARA CAJA MÚLTIPLE - SIN PINTURA

CON ROSCA

	CÓDIGO	CALIBRE ROSCA	CALIBRE TUBO	CANT. EMB.	DIMENSIONES (mm)	A	B	C	D	E	F
	E001502030	1/2"	3/4"	30		24	5	24	20,1	17,4	14,3
	E001502040	3/4"	1"	30		26	5	33,8	28,4	18,2	20
	E001502050	1"	1.1/4"	20		28,5	6	39	33,2	22,2	25,4
	E001502060	1.1/4"	1.1/2"	10		32	6	49	43,3	24	34,5
	E001502070	2"	2"	10		43	8,2	57	51,7	32,5	38,5



CONECTOR CORTO PARA CAJA MÚLTIPLE - CON PINTURA

CON ROSCA

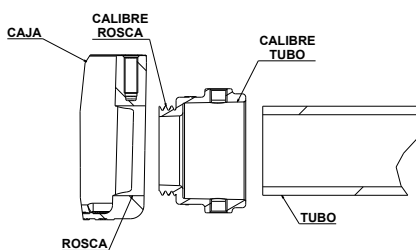
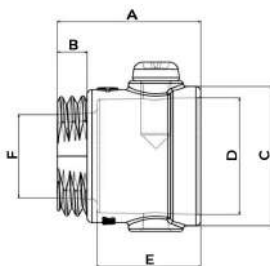
	CÓDIGO	CALIBRE ROSCA	CALIBRE TUBO	CANT. EMB.	DIMENSIONES (mm)	A	B	C	D	E	F
	E001132030	1/2"	3/4"	30		24	5	24	20,1	17,4	14,3
	E001132040	3/4"	1"	30		26	5	33,8	28,4	18,2	20
	E001132050	1"	1.1/4"	20		28,5	6	39	33,2	22,2	25,4
	E001132060	1.1/4"	1.1/2"	10		32	6	49	43,3	24	34,5
	E001132070	2"	2"	10		43	8,2	57	51,7	32,5	38,5



TAPAS PARA CAJA MÚLTIPLE POLIWETZEL - PLATA

	CÓDIGO	CALIBRE	DESCRIPCIÓN	CANT. EMB.
	E011302012	1/2" y 3/4"	CIEGA	24
	E011322032	1"	CIEGA	24



* Acompaña 2 tornillos

TAPAS PARA CAJA MÚLTIPLE POLIWETZEL - SIN PINTURA

	CÓDIGO	CALIBRE	DESCRIPCIÓN	CANT. EMB.
	E011122012	1/2" y 3/4"	CIEGA	24
	E011122032	1"	CIEGA	24

* Acompaña 2 tornillos





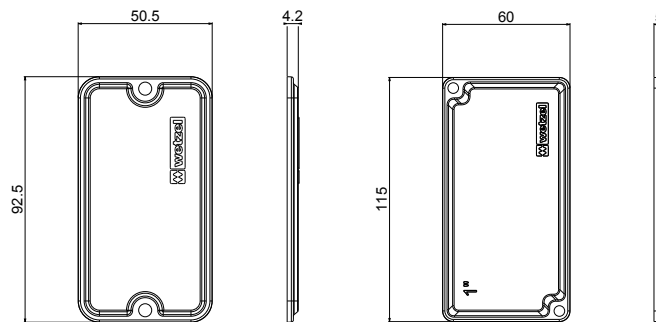

TAPAS PARA CAJA MÚLTIPLE POLIWETZEL - CON PINTURA

	CÓDIGO	CALIBRE	DESCRIPCIÓN	CANT. EMB.
	E011102012	1/2" y 3/4"	CIEGA	24
	E011102032	1"	CIEGA	24

* Acompaña 2 tornillos



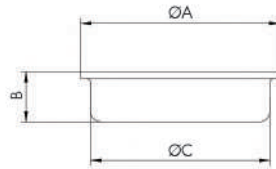

TAPÓN PVC PARA CAJA MÚLTIPLE

	CÓDIGO	CALIBRE	CANT. EMB.	DIMENSIONES (mm)	ØA	B	ØC
	E001284002	1/2"	100		22,6	7	19,8
	E001284003	3/4"	100		28	7	25,2
	E001284004	1"	40		34,8	7	31,8
	E001284005	1.1/4"	40		52,1	7,7	46,5
	E001284006	1.1/2"	40		52,1	7,7	46,5
	E001284009	2"	40		64	8,5	56



TAPÓN ALUMINIO PARA CAJA MÚLTIPLE - PLATA

	CÓDIGO	CALIBRE	CANT. EMB.	DIMENSIONES (mm)	ØA	B	C
	E501152020	1/2"	0		24,5	1/2"	8
	E501152030	3/4"	0		31,8	3/4"	9
	E501152040	1"	0		36,8	1"	9

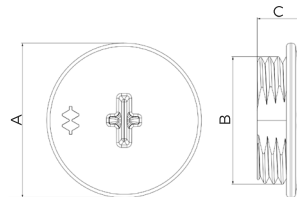

CAJA
BASTIDOR
(PORTA PLAQUETA)

PLATA - SIN PINTURA -CON PINTURA

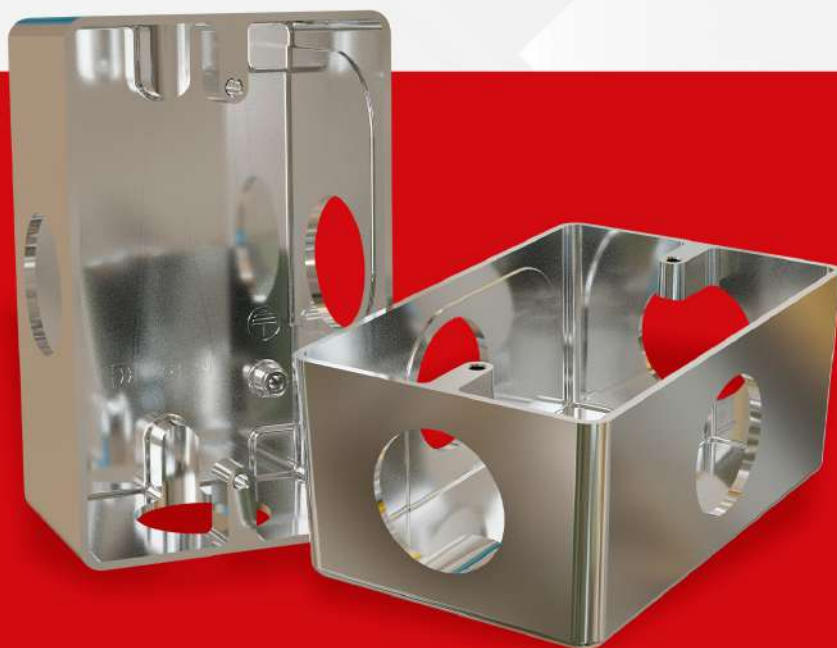

CONOZCA MÁS SOBRE

• DISPONIBLE EN COLORES:



SIN PINTURA

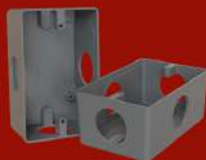

CON PINTURA
GRIS MUNSELL 6.5



PLATA







• CON TORNILLO PARA
PUNTO DE ATERRAMIENTO



CAJA MÚLTIPLE BASTIDOR - PLATA





CUERPO, 3 TAPONES, TORNILLOS PARA TAPA Y 1 TORNILLO PARA ATERRAMIENTO

	CÓDIGO	CALIBRE ROSCA	CANT. EMB.	DIMENSIONES (mm)	A	B	C	D	E
	E002750021	-	4		72	114	48,5	-	83,5
	E002750031	1/2"	4		72	114	48,5	22	83,5
	E002750041	3/4"	4		72	114	48,5	22	83,5
	E002750051	1"	4		72	114	48,5	25	83,5

* Acompaña 2 tornillos para tapa, 1 en la punto de aterramiento y 3 tápones.

CAJA MÚLTIPLE BASTIDOR - SIN PINTURA





CUERPO, 3 TAPONES, TORNILLOS PARA TAPA Y 1 TORNILLO PARA ATERRAMIENTO

	CÓDIGO	CALIBRE ROSCA	CANT. EMB.	DIMENSIONES (mm)	A	B	C	D	E
	E002550021	-	4		72	114	48,5	-	83,5
	E002550031	1/2"	4		72	114	48,5	22	83,5
	E002550041	3/4"	4		72	114	48,5	22	83,5
	E002550051	1"	4		72	114	48,5	25	83,5

* Acompaña 2 tornillos para tapa, 1 en la punto de aterramiento y 3 tápones.

CAJA MÚLTIPLE BASTIDOR - CON PINTURA

CUERPO, 3 TAPONES, TORNILLOS PARA TAPA Y 1 TORNILLO PARA ATERRAMIENTO



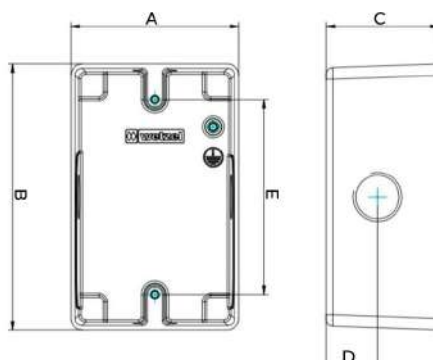

	CÓDIGO	CALIBRE ROSCA	CANT. EMB.	DIMENSIONES (mm)	A	B	C	D	E
	E002350021	-	4		72	114	48,5	-	83,5
	E002350031	1/2"	4		72	114	48,5	22	83,5
	E002350041	3/4"	4		72	114	48,5	22	83,5
	E002350051	1"	4		72	114	48,5	25	83,5

* Acompaña 2 tornillos para tapa, 1 en la punto de aterramiento y 3 tápones.



CAJA MÚLTIPLE BASTIDOR - PLATA





CUERPO, TAPA, 3 TAPONES, TORNILLOS PARA TAPA Y 1 TORNILLO PARA ATERRAMIENTO

	CÓDIGO	CALIBRE ROSCA	CANT. EMB.	DIMENSIONES (mm)	A	B	C
	E002750121	-	4		76,5	119	51,5
	E002750131	1/2"	4		76,5	119	51,5
	E002750141	3/4"	4		76,5	119	51,5
	E002750151	1"	4		76,5	119	51,5

* Acompaña 2 tornillos para tapa, 1 en la punto de aterramiento y 3 tápones.

CAJA MÚLTIPLE BASTIDOR - SIN PINTURA





CUERPO, TAPA, 3 TAPONES, TORNILLOS PARA TAPA Y 1 TORNILLO PARA ATERRAMIENTO

	CÓDIGO	CALIBRE ROSCA	CANT. EMB.	DIMENSIONES (mm)	A	B	C
	E002550121	-	4		76,5	119	51,5
	E002550131	1/2"	4		76,5	119	51,5
	E002550141	3/4"	4		76,5	119	51,5
	E002550151	1"	4		76,5	119	51,5

* Acompaña 2 tornillos para tapa, 1 en la punto de aterramiento y 3 tápones.

CAJA MÚLTIPLE BASTIDOR - CON PINTURA

CUERPO, TAPA, 3 TAPONES, TORNILLOS PARA TAPA Y 1 TORNILLO PARA ATERRAMIENTO

	CÓDIGO	CALIBRE ROSCA	CANT. EMB.	DIMENSIONES (mm)	A	B	C
	E002350121	-	4		76,5	119	51,5
	E002350131	1/2"	4		76,5	119	51,5
	E002350141	3/4"	4		76,5	119	51,5
	E002350151	1"	4		76,5	119	51,5

* Acompaña 2 tornillos para tapa, 1 en la punto de aterramiento y 3 tápones.

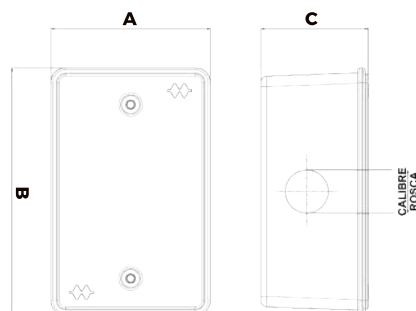

PRÓXIMAMENTE

TAPA PARA CAJA MÚLTIPLE BASTIDOR - PLATA

	CÓDIGO	CALIBRE	DESCRIPCIÓN	CANT. EMB.
	E011750021	1/2", 3/4" y 1"	CIEGA	4

PRÓXIMAMENTE

TAPA PARA CAJA MÚLTIPLE BASTIDOR - SIN PINTURA

	CÓDIGO	CALIBRE	DESCRIPCIÓN	CANT. EMB.
	E011550021	1/2", 3/4" y 1"	CIEGA	4

PRÓXIMAMENTE

TAPA PARA CAJA MÚLTIPLE BASTIDOR - CON PINTURA

	CÓDIGO	CALIBRE	DESCRIPCIÓN	CANT. EMB.
	E011350021	1/2", 3/4" y 1"	CIEGA	4

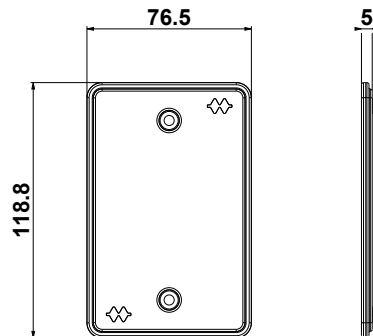

ACCESORIOS



TORNILLOS PARA
UNA MEJOR FIJACIÓN

CONOZCA MÁS SOBRE

LÍNEA PROFESIONAL

- + RESISTENCIA PARA INSTALACIONES PROFESIONALES
- + ROBUSTEZ
- ✓ MÁS LARGO
- ✓ MÁS PESADO
- ✓ MÁS HILO





LÍNEA PRÁCTICA

- + PRACTICIDAD PARA INSTALACIONES DE PESO LIGERO
- + ECONOMÍA







CONECTOR RECTO LARGO - PLATA

LÍNEA PROFESIONAL

	CÓDIGO	CALIBRE ROSCA	CALIBRE TUBO	CANT. EMB.	DIMENSIONES (mm)	A	B	ØC	ØD	E	ØF
	E001072030	1/2"	3/4"	20		47	14	29,6	22,2	31	14,5
	E001072040	3/4"	1"	20		50	14,9	35,7	29,1	33,6	20,2
	E001072050	1"	1.1/4"	20		55	16	43,3	35	36,5	25,4
	E001072060	1.1/4"	1.1/2"	20		60	18,9	53	44	38	31,8
	E001072070	2"	2"	20		67	20	60	52,5	44	47

CONECTOR RECTO LARGO - SIN PINTURA

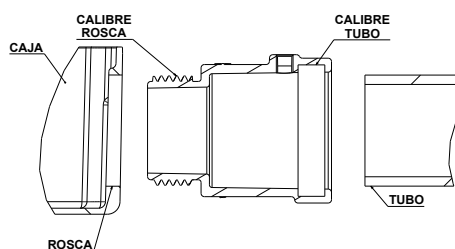
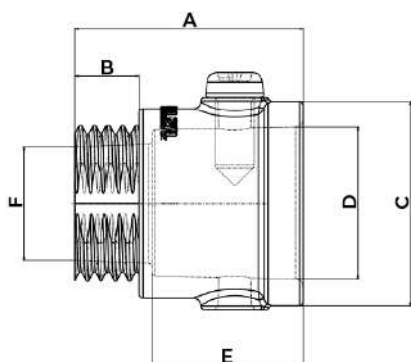

LÍNEA PROFESIONAL

	CÓDIGO	CALIBRE ROSCA	CALIBRE TUBO	CANT. EMB.	DIMENSIONES (mm)	A	B	ØC	ØD	E	ØF
	E001052030	1/2"	3/4"	20		47	14	29,6	22,2	31	14,5
	E001052040	3/4"	1"	20		50	14,9	35,7	29,1	33,6	20,2
	E001052050	1"	1.1/4"	20		55	16	43,3	35	36,5	25,4
	E001052060	1.1/4"	1.1/2"	20		60	18,9	53	44	38	31,8
	E001052070	2"	2"	20		67	20	60	52,5	44	47





CONECTOR RECTO CORTO - PLATA

LÍNEA PRÁCTICA

	CÓDIGO	CALIBRE ROSCA	CALIBRE TUBO	CANT. EMB.	DIMENSIONES (mm)	A	B	ØC	ØD	E	ØF
	E001082030	1/2"	3/4"	20		30	8,3	27	20,1	20	15
	E001082040	3/4"	1"	20		33	11	31	27	20	20
	E001082050	1"	1.1/4"	20	36	11	38,5	34	23,6	25,5	

CONECTOR RECTO CORTO - SIN PINTURA

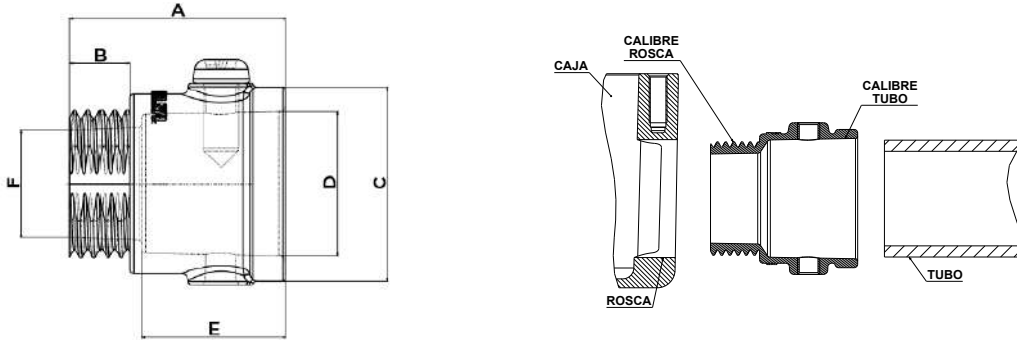

LÍNEA PRÁCTICA

	CÓDIGO	CALIBRE ROSCA	CALIBRE TUBO	CANT. EMB.	DIMENSIONES (mm)	A	B	ØC	ØD	E	ØF
	E001062030	1/2"	3/4"	20		30	8,3	27	20,1	20	15
	E001062040	3/4"	1"	20		33	11	31	27	20	20
	E001062050	1"	1.1/4"	20		36	11	38,5	34	23,6	25,5



EMPALME - PLATA



LÍNEA PROFESIONAL

	CÓDIGO	CALIBRE TUBO	CANT. EMB.	DIMENSIONES (mm)	A	ØC	ØD	E	ØF
	E001102030	3/4"	20		55	29,8	20,8	26,2	19
	E001102040	1"	20		64	35,9	27,4	30,7	24
	E001102050	1.1/4"	20		66	43,4	33,8	31,7	31

* Abajo consulta

EMPALME - SIN PINTURA

LÍNEA PROFESIONAL

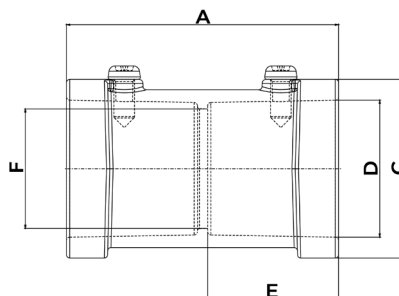

	CÓDIGO	CALIBRE TUBO	CANT. EMB.	DIMENSIONES (mm)	A	ØC	ØD	E	ØF
	E001102031	3/4"	20		55	29,8	20,8	26,2	19
	E001102041	1"	20		64	35,9	27,4	30,7	24
	E001102051	1.1/4"	20		66	43,4	33,8	31,7	31

* Abajo consulta



EMPALME PRÁCTICO - PLATA



LÍNEA PRÁCTICA

	CÓDIGO	CALIBRE TUBO	CANT. EMB.	DIMENSIONES (mm)	A	ØC	ØD
	E001112040	1"	20		46	31,5	26,5
	E001112050	1.1/4"	20	46,5			

* Abajo consulta

EMPALME PRÁCTICO - SIN PINTURA

LÍNEA PRÁCTICA

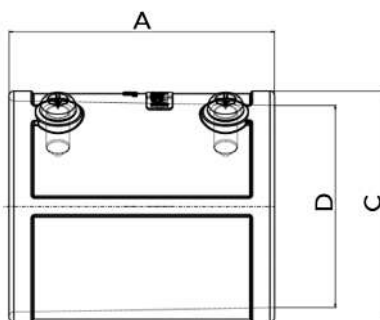

	CÓDIGO	CALIBRE TUBO	CANT. EMB.	DIMENSIONES (mm)	A	ØC	ØD
	E001112041	1"	20		46	31,5	26,5
	E001112051	1.1/4"	20	46,5			

* Abajo consulta





CONECTOR RECTO TIPO BOX - SIN PINTURA

LÍNEA PROFESIONAL

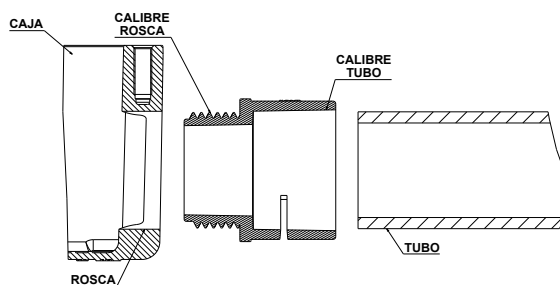
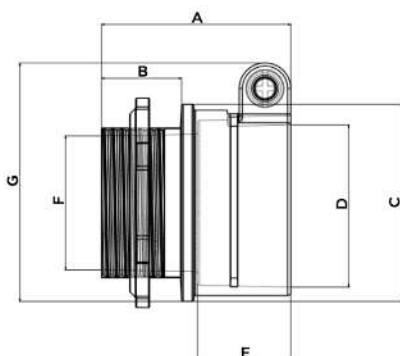

	CÓDIGO	CALIBRE ROSCA	CALIBRE TUBO	CANT. EMB.	DIMENSIONES (mm)	A	B	ØC	ØD	E	ØF	G						
	E001042030	1/2"	3/4"	20		32,5	12	27	22	18	15,5	33,5						
	E001042040	3/4"	1"	20	33,7								12,5	32	27,1	18,5	20	39,7
	E001042050	1"	1.1/4"	20	37								15	40	34,7	20	26,4	49



CONECTOR CURVO TIPO BOLSA (CODO) - PLATA



	CÓDIGO	CALIBRE TUBO	CANT. EMB.	DIMENSIONES (mm)	A	C	ØD	E
	E001032030	3/4"	20		52,2	52,2	20,3	22,2
	E001032040	1"	20		62,4	62,4	26,7	26,3
	E001032050	1.1/4"	20		73,5	73,5	33,2	28,9

CONECTOR CURVO TIPO BOLSA (CODO) - SIN PINTURA

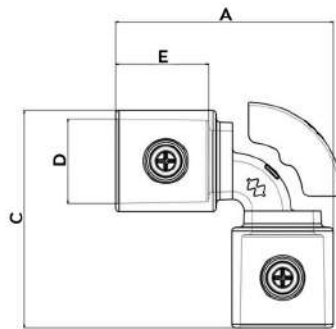
	CÓDIGO	CALIBRE TUBO	CANT. EMB.	DIMENSIONES (mm)	A	C	ØD	E
	E001022030	3/4"	20		52,2	52,2	20,3	22,2
	E001022040	1"	20		62,4	62,4	26,7	26,3
	E001022050	1.1/4"	20		73,5	73,5	33,2	28,9







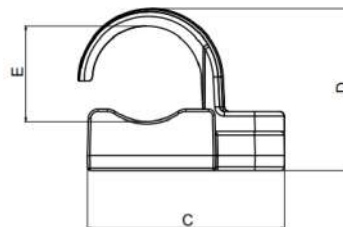





ABRAZADERA TIPO UÑA - SIN PINTURA

	CÓDIGO	CALIBRE TUBO	CANT. EMB.	DIMENSIONES (mm)	ØA	B	C	D	ØE	
									Ø MÍN.	Ø MAX.
	E001302040	3/4"	20	6,5	22,4	51	39,6	25,2	27,4	
	E001302050	1"	20							6,5



ARANDELA

	CÓDIGO	CALIBRE ROSCA	CANT. EMB.	DIMENSIONES (mm)	A	ØC
	E001012011	3/8"	100		4	28,5
	E001012021	1/2"	100		4	28,5
	E001012031	3/4"	100		4,2	34
	E001012041	1"	100		4,5	42,5
	E001012051	1.1/4"	100		5	53
	E001012061	1.1/2"	100		5	58
	E001012071	2"	100		5,5	72
	E001012081	2.1/2"	50		6,5	86,5
	E001012091	3"	20		8	100,5
	E001012111	4"	20	8,5	128	





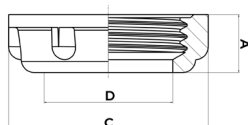

BOQUILLA

	CÓDIGO	CALIBRE ROSCA	CANT. EMB.	DIMENSIONES (mm)	A	ØC	ØD
	E001020011	3/8"	50		7,5	25,5	12
	E001022021	1/2"	100		9	25,5	15
	E001022031	3/4"	100		9	31	20
	E001022041	1"	100		10	39	26,3
	E001022051	1.1/4"	100		11	48	32,5
	E001022061	1.1/2"	100		12,5	54,5	40
	E001022071	2"	50		13	66,5	52
	E001022081	2.1/2"	25		15,5	83,5	65
	E001022091	3"	10		16,5	97	77
	E001022111	4"	10	18	122	101	



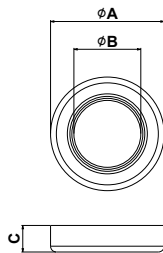

ANILLO DE ESTANQUEIDAD

	CÓDIGO	CALIBRE TUBO	CANT. EMB.	DIMENSIONES (mm)	ØA	B	C
	E002142113	3/4"	12		32,5	21,5	6
	E002142114	1"	12		39,8	27,5	7
	E002142115	1.1/4"	12		49,5	36	8
	E002142116	1.1/2"	12		56,5	42	9,5
	E060142117	2"	12		68,5	53,5	9,5





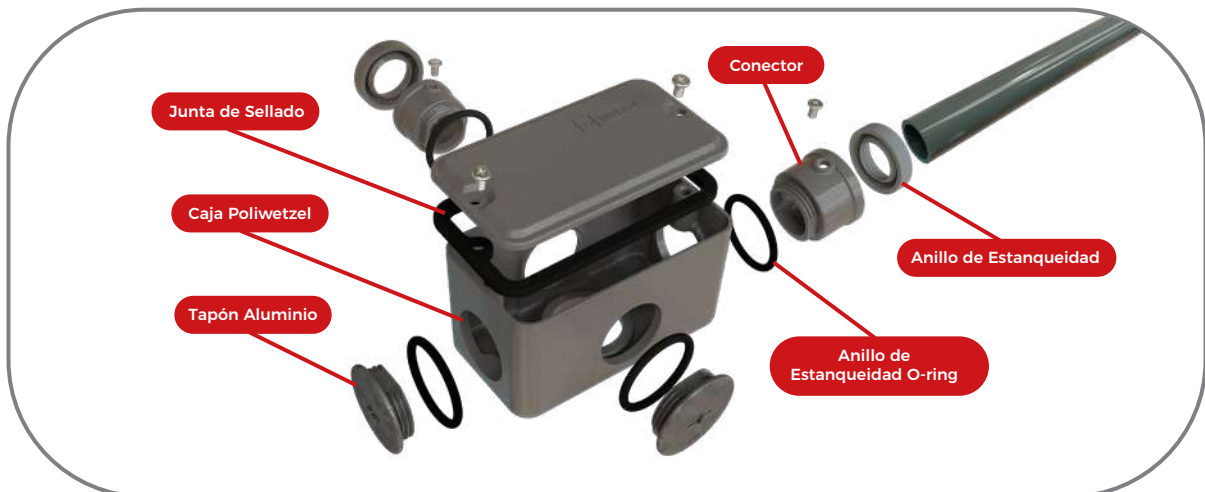
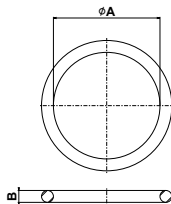

ANILLO DE ESTANQUEIDAD O-RING





	CÓDIGO	CALIBRE ROSCA	CANT. EMB.	DIMENSIONES (mm)	ØA	ØB
	E020142009	1/2"	12		17,1	2,6
	E002142012	3/4"	12		21,8	2,6
	E002142013	1"	12		29,8	2,6



JUNTA DE VEDACIÓN PVC

	CÓDIGO	CALIBRE	CANT. EMB.	DIMENSIONES (mm)	A	B	C
	E002141001	1/2" y 3/4"	12		95	53	3
	E002141007	1"	12		118	63	5
	E002141009	1.1/4" y 1.1/2"	12		144,5	83,5	3,5
	E002141010	2"	12		164,5	93,5	3,5

JUNTA DE VEDACIÓN POLICLOROPRENO

	CÓDIGO	CALIBRE	CANT. EMB.	DIMENSIONES (mm)	A	B	C
	E002141101	1/2" y 3/4"	12		95,5	53,5	4
	E002141103	1"	12		119,3	64,3	5,5
	E002141105	1.1/4" y 1.1/2"	12		144,3	84,2	6
	E002141106	2"	12		164,4	94,3	6

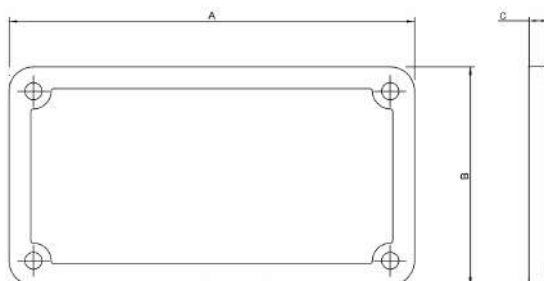

CAJA DE
PASO
SIN PINTURA - CON PINTURA

TORNILLOS
ORGANOMETÁLICO



TAPA REVERSIBLE
LISA Y ANTIDESLIZANTE

CONOZCA MÁS SOBRE

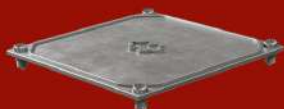

OPCIÓN DE CHASIS PARA FIJAR LOS COMPONENTES ELÉCTRICOS.

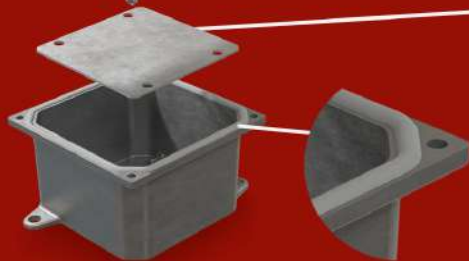

• SELLADO EN POLICLOROPRENO QUE OFRECE DE PROTECCIÓN ENTRE EL MONTAJE DEL CUERPO Y LA TAPA.







CON PUNTO DE ATERRAMIENTO

+ PROTECCION **IP65**



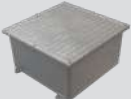

CAJA DE PASO - SIN PINTURA

TAPA REVERSIBLE - SIN CHASIS - CON 1 TORNILLO PARA ATERRAMIENTO

	CÓDIGO	TAMAÑO	CANT. EMB.
	E007010013	10x10	4
	E007010026	15x15	3
	E007010038	20x20	2
	E007010042	30x30	1
	E007010312	40x40	1

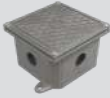
TAPA REVERSIBLE - SIN CHASIS CON 4 AGUJEROS - CON 1 TORNILLO PARA ATERRAMIENTO

	CÓDIGO	TAMAÑO	CALIBRE ROSCA AGUJEROS	CANT. EMB.
	E007012011	10x10	1/2"	4
	E007012012	10x10	3/4"	4

TAPA LISA - SIN CHASIS - CON 1 TORNILLO PARA ATERRAMIENTO

	CÓDIGO	TAMAÑO	CANT. EMB.
	E007010052	40x20	1





TAPA ANTIDESLIZANTE - SIN CHASIS - CON 1 TORNILLO PARA ATERRAMIENTO

	CÓDIGO	TAMAÑO	CANT. EMB.
	E007010102	40x20	1

* Acompaña tornillo en el punto de aterramiento.

CAJA DE PASO - SIN PINTURA

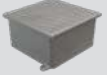
TAPA REVERSIBLE - CON CHASIS - CON 1 TORNILLO PARA ATERRAMIENTO

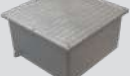
	CÓDIGO	TAMAÑO	CANT. EMB.
	E007012115	10x10	4
	E007012125	15x15	3
	E007012135	20x20	2
	E007012145	30x30	1
	E007012316	40x40	1

TAPA LISA - CON CHASIS - CON 1 TORNILLO PARA ATERRAMIENTO

	CÓDIGO	TAMAÑO	CANT. EMB.
	E007012155	40x20	1

TAPA ANTIDESLIZANTE - CON CHASIS - CON 1 TORNILLO PARA ATERRAMIENTO

	CÓDIGO	TAMAÑO	CANT. EMB.
	E007012205	40x20	1



* Acompaña tornillo en el punto de aterramiento.

CAJA DE PASO - CON PINTURA

TAPA REVERSIBLE - SIN CHASIS - CON 1 TORNILLO PARA ATERRAMIENTO

	CÓDIGO	TAMAÑO	CANT. EMB.
	E007012010	10x10	4
	E007012020	15x15	3
	E007012030	20x20	2
	E007012040	30x30	1
	E007012310	40x40	1

TAPA REVERSIBLE - SIN CHASIS CON 4 AGUJEROS - CON 1 TORNILLO PARA ATERRAMIENTO

	CÓDIGO	TAMAÑO	CALIBRE ROSCA AGUJEROS	CANT. EMB.
	E007012013	10x10	1/2"	4
	E007012014	10x10	3/4"	4

TAPA LISA - SIN CHASIS - CON 1 TORNILLO PARA ATERRAMIENTO

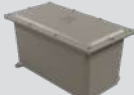
	CÓDIGO	TAMAÑO	CANT. EMB.
	E007012050	40x20	1





TAPA ANTIDESLIZANTE - SIN CHASIS - CON 1 TORNILLO PARA ATERRAMIENTO

	CÓDIGO	TAMAÑO	CANT. EMB.
	E007012100	40x20	1

* Acompaña tornillo en el punto de aterramiento.

CAJA DE PASO - CON PINTURA

TAPA REVERSIBLE - CON CHASIS - CON 1 TORNILLO PARA ATERRAMIENTO

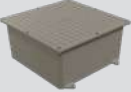
	CÓDIGO	TAMAÑO	CANT. EMB.
	E007012110	10x10	4
	E007012120	15x15	3
	E007012130	20x20	2
	E007012140	30x30	1
	E007012311	40x40	1

TAPA LISA - CON CHASIS - CON 1 TORNILLO PARA ATERRAMIENTO

	CÓDIGO	TAMAÑO	CANT. EMB.
	E007012150	40x20	1

TAPA ANTIDESLIZANTE - CON CHASIS - CON 1 TORNILLO PARA ATERRAMIENTO

	CÓDIGO	TAMAÑO	CANT. EMB.
	E007012200	40x20	1

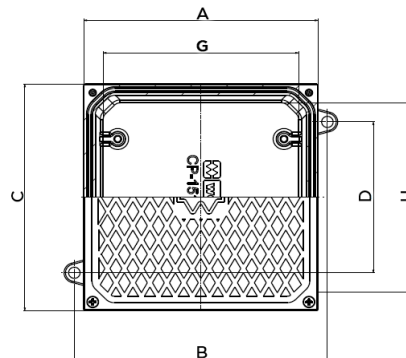

* Acompaña tornillo en el punto de aterramiento..



DIMENSIONES (mm)

TAMAÑO	A	B	C	D	E	F	G	H
10x10	108	116	108	56	65,5	57,5	93	93
15x15	159	172	159	106	105,8	97,5	143	143
20x20	212	220	212	152	106	97,5	194	194
30x30	320	310	320	220	126	116	282	282
40x40	440	433	440	340	206,5	196	400	400
40x20	227	210	227	330	212	195	181	379

BAJO PEDIDO se puede proporcionar las cajas con agujero perforado.

DIÁMETRO(Ø) MÁXIMO DE AGUJEROS POR CARA (CUADRADA)			
TAMAÑO	 UNO	 DOS	 TRES
10x10	1"	3/4"	-
15x15	2"	1.1/4"	3/4"
20x20	2.1/2"	2"	1"
30x30	3"	2.1/2"	2"
40x40	4"	4"	3"

DIÁMETRO(Ø) MÁXIMO DE AGUJEROS POR CARA (RECTANGULAR)						
TAMAÑO	 UNO		 DOS		 TRES	
	LARGO	ANCHO	LARGO	ANCHO	LARGO	ANCHO
40x20	4"	2.1/2"	4"	2"	3"	1"

Disposición de las Entradas

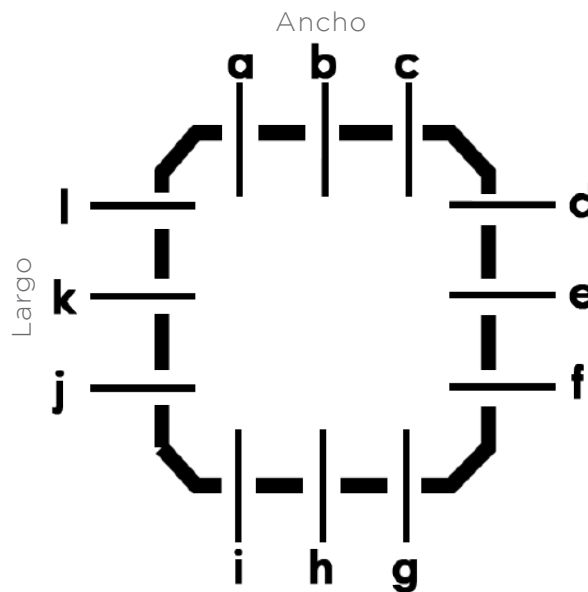

COMO SOLICITAR				
Código	E007010130			
Posiciones	"a" - 1"	"c" - 1"	"d" - 1"	"f" - 1"
				

*Para más informaciones, entre en contacto nuestro departamento comercial

CAJA MÚLTIPLE
REDONDA
PLATA - SIN PINTURA - CON PINTURA



CONOZCA MÁS SOBRE

• DISPONIBLE EN COLORES:



SIN PINTURA

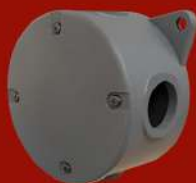

CON PINTURA
GRIS MUNSELL 6.5



PLATA



• SELLO DE ESTIRENO BUTADIENO





• PUNTO DE ATERRAMIENTO
(INCLUYE TERMINAL)





CAJA MÚLTIPLE REDONDA - PLATA

DIÁMETRO PEQUEÑO - CON 1 TORNILLO PARA ATERRAMIENTO

	CÓDIGO	CALIBRE ROSCA	CANT. EMB.
	E007032015	1/2"	1
	E007032025	3/4"	1



CAJA MÚLTIPLE REDONDA - SIN PINTURA

DIÁMETRO PEQUEÑO - CON 1 TORNILLO PARA ATERRAMIENTO

	CÓDIGO	CALIBRE ROSCA	CANT. EMB.
	E007032017	1/2"	1
	E007032027	3/4"	1

CAJA MÚLTIPLE REDONDA - CON PINTURA

DIÁMETRO PEQUEÑO - CON 1 TORNILLO PARA ATERRAMIENTO

	CÓDIGO	CALIBRE ROSCA	CANT. EMB.
	E007032010	1/2"	1
	E007032020	3/4"	1

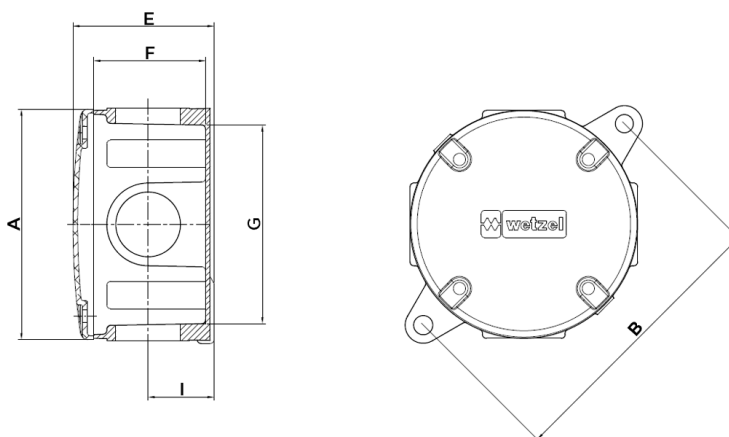



DIMENSIONES (mm)

MEDIDA	Ø A	B	E	F	Ø G	I
1/2"	95	110	54	43	78	22
3/4"						



CAJA MÚLTIPLE REDONDA - PLATA

DIÁMETRO MEDIO - CON 1 TORNILLO PARA ATERRAMIENTO

	CÓDIGO	CALIBRE ROSCA	CANT. EMB.
	E007030098	1/2"	1
	E007030088	3/4"	1
	E007032091	1"	1



CAJA MÚLTIPLE REDONDA - SIN PINTURA

DIÁMETRO MEDIO - CON 1 TORNILLO PARA ATERRAMIENTO

	CÓDIGO	CALIBRE ROSCA	CANT. EMB.
	E007032071	1/2"	1
	E007032081	3/4"	1
	E007032097	1"	1

CAJA MÚLTIPLE REDONDA - CON PINTURA

DIÁMETRO MEDIO - CON 1 TORNILLO PARA ATERRAMIENTO

	CÓDIGO	CALIBRE ROSCA	CANT. EMB.
	E007032095	1/2"	1
	E007032105	3/4"	1
	E007032115	1"	1

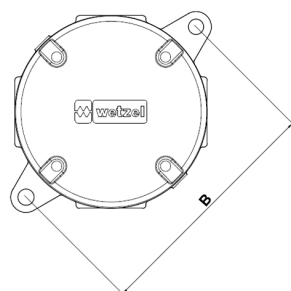
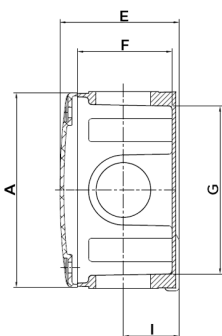

DIMENSIONES (mm)

MEDIDA	Ø A	B	E	F	Ø G	I
1/2"						
3/4"	105	115	56	38	86	25
1"						

CAJA DE DERIVACIÓN
REFORZADA
CON PINTURA



TORNILLOS HEXAGONALES
EN ACERO INOXIDABLE

CONOZCA MÁS SOBRE



TORNILLO HEXAGONAL E
ARANDELA A PRESIÓN PARA
ASEGURAR UNA MAYOR FIJACIÓN

CHASIS PARA FIJACIÓN DE
COMPONENTES ELÉCTRICOS











CON PUNTO DE ATERRAMIENTO

+ PROTEÇÃO **IP65**

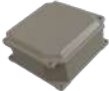











CAJA DE DERIVACIÓN REFORZADA CON PINTURA

SIN CHASIS - CON 1 TORNILLO PARA ATERRAMIENTO

	CÓDIGO	TAMAÑO	CANT. EMB.
	E007042010	17x14	1
	E007042020	22X22	1
	E007042030	28x14	1
	E007042040	28X28	1
	E007042050	34x14	1
	E007042060	34x28	1
	E007042070	40x28	1
	E007042080	40x35	1
	E007042090	45x28	1
	E007042100	56x28	1

CAJA DE DERIVACIÓN REFORZADA CON PINTURA

CON CHASIS - CON 1 TORNILLO PARA ATERRAMIENTO

	CÓDIGO	TAMAÑO	CANT. EMB.
	E007142010	17x14	1
	E007142020	22X22	1
	E007142030	28x14	1
	E007142040	28X28	1
	E007142050	34x14	1
	E007142060	34x28	1
	E007142070	40x28	1
	E007142080	40x35	1
	E007142090	45x28	1
	E007142100	56x28	1

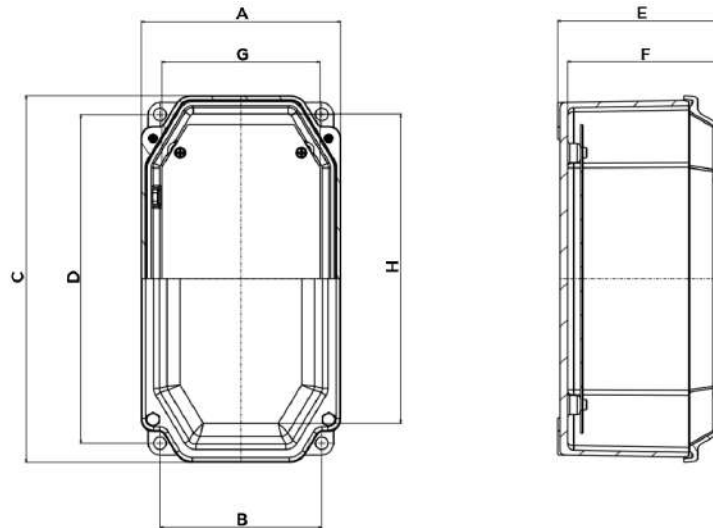

DIMENSIONES (mm)								
TAMAÑO	A	B	Ø C	Ø D	E	Ø F	G	H
17x14	158	127,8	188	156,8	134	125	148	178
28x14	158	127,8	291	260,8	134	125	148	281
28x28	291	259,4	291	259,4	134	125	281	281
34x14	158	127,8	357	326,8	134	125	148	347
22x22	237	205,4	235	203,4	174	165	227	225
34x28	291	258	358	325	174	165	281	348
40x28	291	259,4	416	384,4	174	165	281	406
45x28	291	259,4	461	430,8	174	165	281	451
56x28	291	259,4	571	540,8	174	165	281	561
40x35	369	335,3	416	382,3	174	225	359	406

BAJO PEDIDO se puede proporcionar las cajas con agujero perforado, siendo las opciones: Con rosca BSP o NPT.

TAMAÑO	DIÁMETRO(Ø) MÁXIMO DE AGUJEROS POR CARA (RECTANGULAR)					
	UNO		DOS		TRES	
	LARGO	ANCHO	LARGO	ANCHO	LARGO	ANCHO
17x14	1.1/4"	1.1/2"	-	1/2"	-	-
28x14	2"	1.1/2"	1.1/2"	1/2"	1"	-
28x28	2"	2"	1.1/2"	1/2"	1"	1"
34x14	2"	1.1/2"	2"	1/2"	1.1/2"	-
22x22	2.1/2"	3"	1"	1.1/2"	1/2"	1"
34x28	3"	3"	2.1/2"	3"	1.1/2"	1.1/4"
40x28	3"	3"	3"	3"	2"	1.1/4"
45x28	*	3"	3"	3"	-	1.1/4"
56x28	*	3"	3"	3"	-	1.1/4"
40x35	4"	4"	3"	4"	2"	2"

*Perforación desplazada. En las cajas 45x28 y 56x28 no habrá agujero en el centro de la caja, a lo largo.

CAJA **DE PISO**



DISPONIBLE
•ROSCA BSP

CONOZCA MÁS SOBRE





CAJA DE PISO MODELO BAJA - 4X2 SIN PINTURA

SIN PERFORACIÓN

	CÓDIGO	CALIBRE ROSCA	CANT. EMB.
	E005050130	-	4

CON PERFORACIÓN



	CÓDIGO	CALIBRE ROSCA	CANT. EMB.
	E005050140	1/2"	4
	E005050150	3/4"	4
	E005050160	1"	4

CAJA DE PISO MODELO BAJA - 4X4 SIN PINTURA

SIN PERFORACIÓN

	CÓDIGO	CALIBRE ROSCA	CANT. EMB.
	E005050170	-	4

CON PERFORACIÓN



	CÓDIGO	CALIBRE ROSCA	CANT. EMB.
	E005050180	1/2"	4
	E005050190	3/4"	4
	E005050200	1"	4

CAJA DE PISO MODELO ALTA - 4X4 SIN PINTURA

SIN PERFORACIÓN

	CÓDIGO	CALIBRE ROSCA	CANT. EMB.
	E005050210	-	4

CON PERFORACIÓN

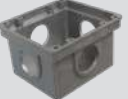

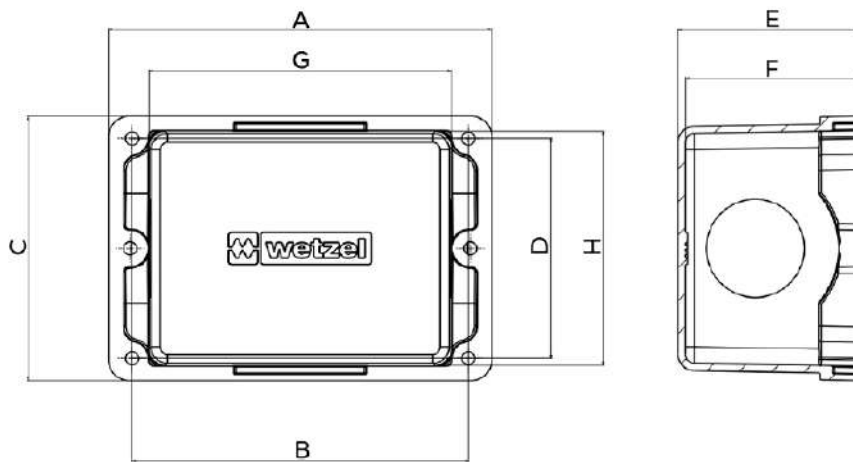
	CÓDIGO	CALIBRE ROSCA	CANT. EMB.
	E005050220	1/2"	4
	E005050230	3/4"	4
	E005050240	1"	4



DIMENSIONES (mm)

TAMAÑO	A	B	Ø C	Ø D	E	Ø F	G	H
BAJA 4X2	94	82,6	65	54	45	43,2	74,1	57,9
BAJA 4X4	94	83,5	100	83,5	45	43,2	75,5	87
ALTA 4X4	94	83,5	100	83,5	63	61,2	75,5	87

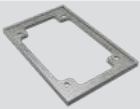
ANILLO DE REGULACIÓN PARA CAJA DE PISO

	CÓDIGO	TAMAÑO	CANT. EMB.
	E005072020	4x2	50
	E005072030	4x4	25

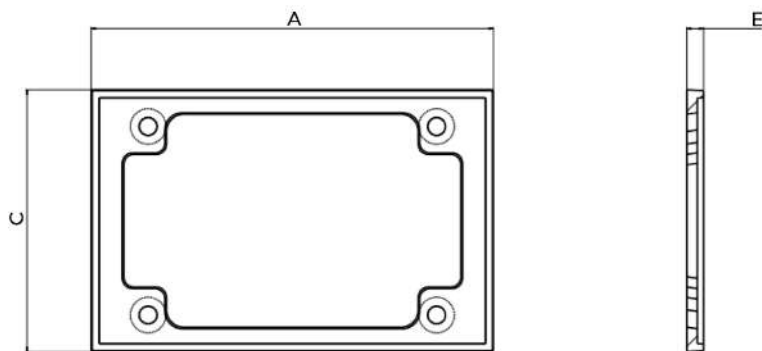

DIMENSIONES (mm)			
TAMAÑO	A	Ø C	E
4x2	115	75	4,8
4x4	115	115	6



WETZEL.COM.BR