



INTERNACIONAL
ARGENTINA | URUGUAY

CATÁLOGO DE PRODUCTOS
ALUMINIO

2023
ABRIL



91 años wetzel

WETZEL SA.

Fundada en 1932 en Joinville (SC), WETZEL es una empresa referencia en los segmentos en que actúa, satisfaciendo las demandas específicas con un alto grado de exigencia.

En la actualidad, la empresa tiene una área de más de 45.000 m² y cuenta con más de 1.300 empleados. Ofrece un portafolio diversificado para quienes necesitan soluciones innovadoras y competitivas.

Con foco en el trabajo en sociedad con sus clientes, ayuda a identificar oportunidades de negocios y desarrolla productos que satisfacen las necesidades de los proyectos y superan las expectativas.

UNIDADES DE NEGOCIOS

COMPONENTES
PARA INSTALACIONES
ELÉCTRICAS INDUSTRIALES

COMPONENTES
DE ILUMINACIÓN
INDUSTRIAL LED

COMPONENTES
AUTOMOVILÍSTICOS EM
ALUMINIO Y HIERRO



COMPONENTES PARA INSTALACIONES ELÉCTRICAS INDUSTRIALES

La unidad de componentes para instalaciones eléctricas industriales tiene como foco en los segmentos de gestión de cables, iluminación industrial convencional y productos para las áreas clasificadas.

Tiene la línea más completa de productos de gestión de cables del mercado. Disponibles en aluminio y plástico, ambos son fabricadas con la más alta calidad.

En la iluminación industrial convencional, la empresa cuenta con el *knowhow* de años como líder del mercado y cuenta con un portafolio amplio y diverso.

Los productos para áreas clasificadas WETZEL siguen la más rigurosas normas de desarrollo y producción, garantizando calidad y seguridad a sus clientes.

www.WETZEL.com.br

ÍNDICE

INTERNACIONAL

■ POLIWETZEL

PLATA	5
SIN PINTURA	9
CON PINTURA	13

■ CAJA BASTIDOR

PLATA.....	18
SIN PINTURA	18
CON PINTURA.....	18

■ ACCESORIOS

CONECTOR RECTO LARGO.....	20
EMPALME.....	22
CONECTOR RECTO BOX.....	24
CODO.....	24
ARANDELA.....	25
BOQUILLA.....	26

■ CAJA DE PASE

SIN PINTURA	28
CON PINTURA	30

■ CAJA DE CONEXIÓN REDONDA

DIÁMETRO PEQUEÑO.....	34
DIÁMETRO MEDIO.....	35

■ CAJA DE CONEXIÓN REFORZADA

CON PINTURA.....	37
------------------	-----------



CAJA MÚLTIPLE
POLIWETZEL
PLATA PULIDO ESPECIAL BRILLO

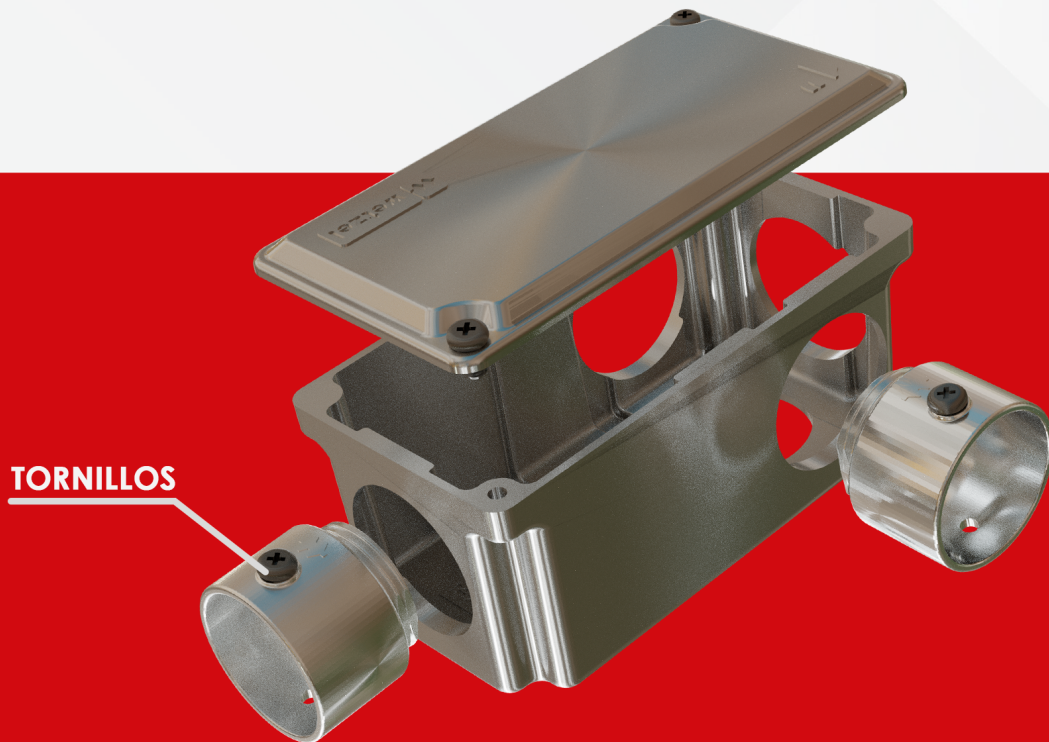

CONOZCA MÁS SOBRE

MODELOS

• DISPONIBLE EN MODELO L (LPW) y X (XPW)



LPW



XPW

DIFERENTE ALTURA EN EL CALIBRE 3/4"

- GARANTIZA MÁS VOLUMEN INTERNO;
- PRACTICIDAD EN LA INSTALACIÓN Y PASO DE CABLES, EVITANDO APLASTAMIENTOS Y REDUCIENDO RIESGOS DE CORTOCIRCUITOS ELÉCTRICOS;



OTROS

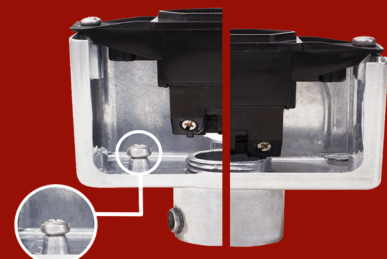

• CON TORNILLO PARA PUNTO DE ATERRAMIENTO

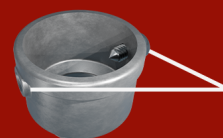





CON 2 PUNTOS DE FIJACIÓN







CAJA MÚLTIPLE POLIWETZEL - PLATA

CUERPO Y 1 TORNILLO PARA ATERRAMIENTO

	CÓDIGO	MODELO	MEDIDA	CANT. EMB.	DIMENSIONES (mm)	A	B	C	D	E
	E002712031	L	3/4"	12		92,5	48	20	50,5	19
	E002712041	L	1"	12		92,5	48	20	50,5	19
	E002712051	L	1,1/4"	12		115	50	25	60	28,5
	E002812031	X	3/4"	12		92,5	48	20	50,5	-
	E002812041	X	1"	12		92,5	48	20	50,5	-
	E002812051	X	1,1/4"	12		115	50	25	60	-

CAJA MÚLTIPLE POLIWETZEL - PLATA

CUERPO CON 3 TAPONES Y 1 TORNILLO PARA ATERRAMIENTO

	CÓDIGO	MODELO	MEDIDA	CANT. EMB.	DIMENSIONES (mm)	A	B	C	D	E
	E002702031	L	3/4"	12		92,5	48	20	50,5	19
	E002702041	L	1"	12		92,5	48	20	50,5	19
	E002702051	L	1,1/4"	12		115	50	25	60	28,5
	E002802031	X	3/4"	12		92,5	48	20	50,5	-
	E002802041	X	1"	12		92,5	48	20	50,5	-
	E002802051	X	1,1/4"	12		115	50	25	60	-

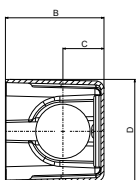

MODELO L

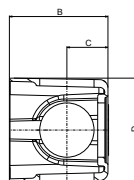
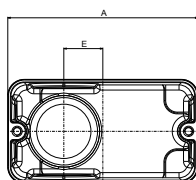

MODELO X

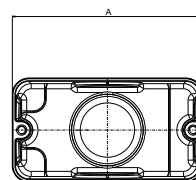

CAJA MÚLTIPLE POLIWETZEL - PLATA

MONTADA - CAJA, TAPA, 3 TAPONES, TORNILLOS Y ATERRAMIENTO

	CÓDIGO	MODELO	MEDIDA	CANT. EMB.	DIMENSIONES (mm)	A	B	C	D	E
	E002700034	L	3/4"	12		92,5	52,2	20	50,5	19
	E002700044	L	1"	12		92,5	52,2	20	50,5	19
	E002700054	L	1.1/4"	12		115	55	25	60	28,5
	E002700064	L	1.1/2"	12		143	76,5	32,5	80	31,5
	E002700074	L	2"	12		160	90,5	42,5	90	35
	E002800034	X	3/4"	12		92,5	52,2	20	50,5	-
	E002800044	X	1"	12		92,5	52,2	20	50,5	-
	E002800054	X	1.1/4"	12		115	55	25	60	-
	E002800064	X	1.1/2"	12		143	76,5	32,5	80	-
	E002800074	X	2"	12	160	90,5	42,5	90	-	

* Acompaña 2 tornillos en la tapa y 1 en la punto de aterramiento

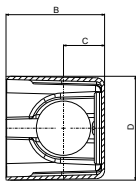

MODELO L

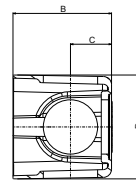
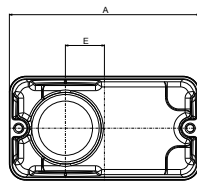

MODELO X

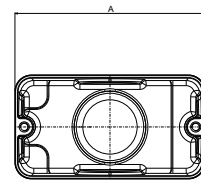

CONECTOR PARA CAJA MÚLTIPLE - PLATA

SIN ROSCA

	CÓDIGO	mm	MEDIDA	CANT. EMB.	DIMENSIONES (mm)	A	B	C	D	E	F
	E001702030	19,05 mm	3/4"	30		24	5	24	20,1	17,4	14,3
	E001702040	25,4 mm	1"	30		26	6	31,8	26,4	18,2	20
	E001702050	31,75 mm	1.1/4"	20		28,5	6	39	33,2	20,2	25,4
	E001702060	38,10 mm	1.1/2"	10		32	6	43,1	39,3	24	34,5
	E001702070	50,8 mm	2"	10		43	8,2	57	51,7	32,5	48

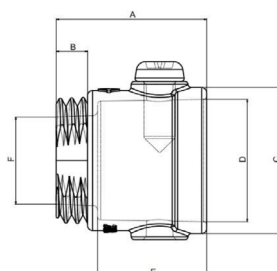

TAPAS - PLATA

	CÓDIGO	DESCRIPCIÓN	MEDIDA	CANT. EMB.
	E011320212	CIEGA	3/4" y 1"	24
	E011322032	CIEGA	1,1/4"	24
	E011322162	PARA UN ENCHUFE REDONDO	3/4" y 1"	24
	E011322322	PARA UN ENCHUFE REDONDO	1,1/4"	24
	E011322122	PARA UN INTERRUPTOR VERTICAL	3/4" y 1"	24
	E011322282	PARA UN INTERRUPTOR VERTICAL	1,1/4"	24
	E011322132	PARA DOS INTERRUPTORES HORIZONTALES JUNTOS	3/4" y 1"	24
	E011322292	PARA DOS INTERRUPTORES HORIZONTALES JUNTOS	1,1/4"	24

* Acompaña 2 tornillos

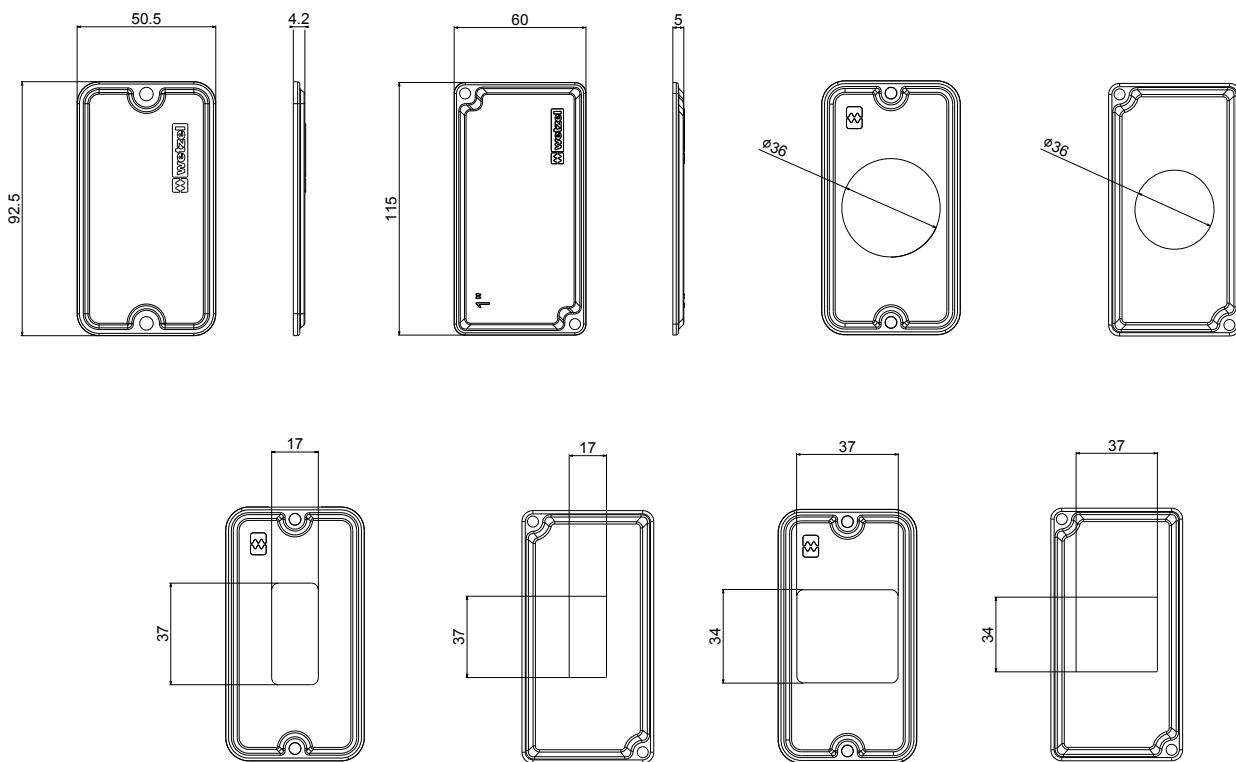

CAJA MÚLTIPLE POLIWETZEL

SIN PINTURA

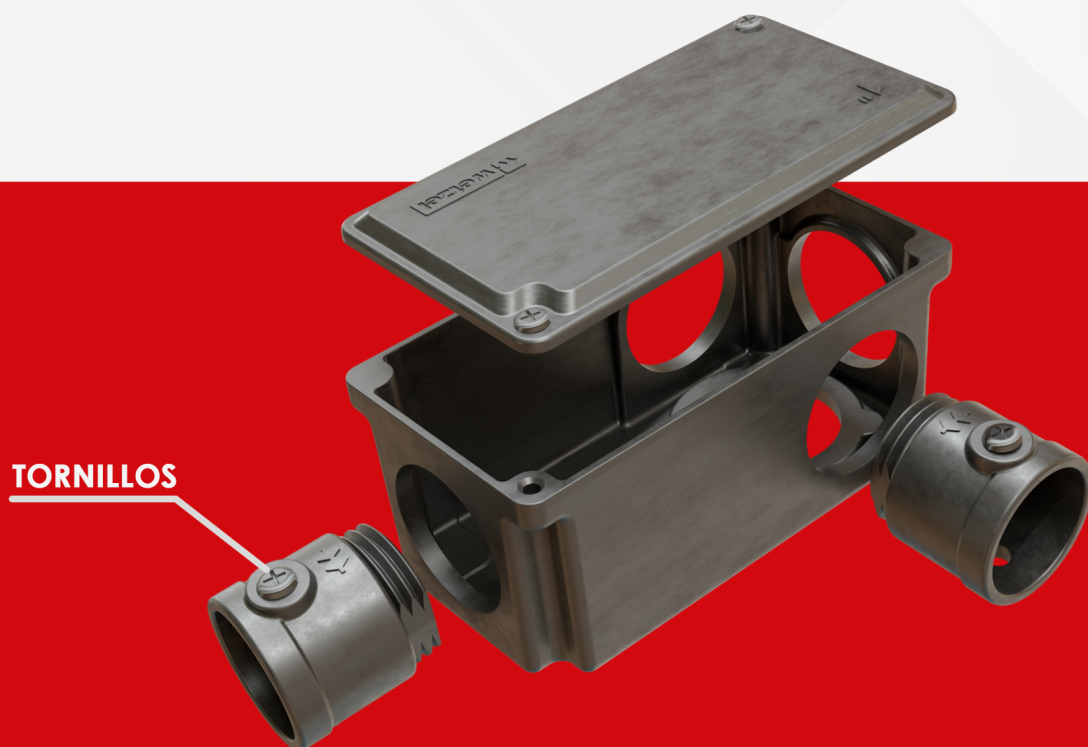

TORNILLOS

CONOZCA MÁS SOBRE

MODELOS

- DISPONIBLE EN MODELO L (LPW) y X (XPW)



LPW



XPW

DIFERENTE ALTURA EN EL CALIBRE 3/4"

- GARANTIZA MÁS VOLUMEN INTERNO;
- PRACTICIDAD EN LA INSTALACIÓN Y PASO DE CABLES, EVITANDO APLASTAMIENTOS Y REDUCIENDO RIESGOS DE CORTOCIRCUITOS ELÉCTRICOS;



OTROS

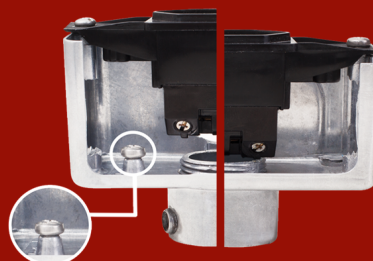

- CON TORNILLO PARA PUNTO DE ATERRAMIENTO

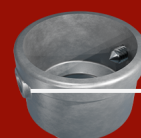





CON
2 PUNTOS
DE FIJACIÓN







CAJA MÚLTIPLE POLIWETZEL - SIN PINTURA

CUERPO Y 1 TORNILLO PARA ATERRAMIENTO

	CÓDIGO	MODELO	MEDIDA	CANT. EMB.	DIMENSIONES (mm)	A	B	C	D	E
	E002512031	L	3/4"	12		92,5	48	20	50,5	19
	E002512041	L	1"	12		92,5	48	20	50,5	19
	E002512051	L	1.1/4"	12		115	50	25	60	28,5
	E002612031	X	3/4"	12		92,5	48	20	50,5	-
	E002612041	X	1"	12		92,5	48	20	50,5	-
	E002612051	X	1.1/4"	12		115	50	25	60	-

CAJA MÚLTIPLE POLIWETZEL - SIN PINTURA

CUERPO CON 3 TAPONES Y 1 TORNILLO PARA ATERRAMIENTO

	CÓDIGO	MODELO	MEDIDA	CANT. EMB.	DIMENSIONES (mm)	A	B	C	D	E
	E002502031	L	3/4"	12		92,5	48	20	50,5	19
	E002502041	L	1"	12		92,5	48	20	50,5	19
	E002502051	L	1.1/4"	12		115	50	25	60	28,5
	E002602031	X	3/4"	12		92,5	48	20	50,5	-
	E002602041	X	1"	12		92,5	48	20	50,5	-
	E002602051	X	1.1/4"	12		115	50	25	60	-

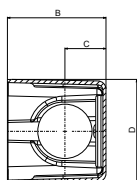

MODELO L

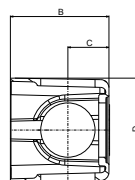
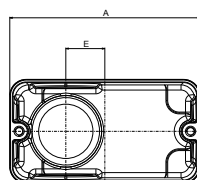

MODELO X

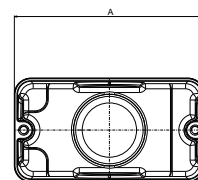

CAJA MÚLTIPLE POLIWETZEL - SIN PINTURA

MONTADA - CAJA, TAPA, 3 TAPONES, TORNILLOS Y ATERRAMIENTO

	CÓDIGO	MODELO	MEDIDA	CANT. EMB.	DIMENSIONES (mm)	A	B	C	D	E
	E002502030	L	3/4"	12		92,5	52,2	20	50,5	19
	E002502040	L	1"	12		92,5	52,2	20	50,5	19
	E002502050	L	1.1/4"	12		115	55	25	60	28,5
	E002502060	L	1.1/2"	12		143	76,5	32,5	80	31,5
	E002502070	L	2"	12		160	90,5	42,5	90	35
	E002602030	X	3/4"	12		92,5	52,2	20	50,5	-
	E002602040	X	1"	12		92,5	52,2	20	50,5	-
	E002602050	X	1.1/4"	12		115	55	25	60	-
	E002602060	X	1.1/2"	12		143	76,5	32,5	80	-
	E002602070	X	2"	12	160	90,5	42,5	90	-	

* Acompaña 2 tornillos en la tapa y 1 en la punto de aterramiento

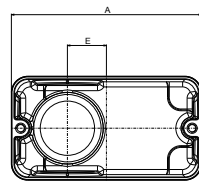
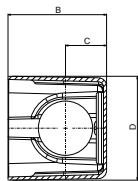

MODELO L

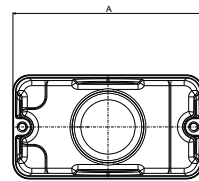
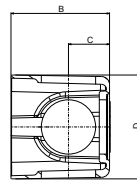

MODELO X

CONECTOR PARA CAJA MÚLTIPLE - SIN PINTURA

SIN ROSCA

	CÓDIGO	mm	MEDIDA	CANT. EMB.	DIMENSIONES (mm)	A	B	C	D	E	F
	E001502030	19,05 mm	3/4"	30		24	5	24	20,1	17,4	14,3
	E001502040	25,4 mm	1"	30		26	6	31,8	26,4	18,2	20
	E001502050	31,75 mm	1.1/4"	20		28,5	6	39	33,2	20,2	25,4
	E001502060	38,10 mm	1.1/2"	10		32	6	43,1	39,3	24	34,5
	E001502070	50,8 mm	2"	10		43	8,2	57	51,7	32,5	48

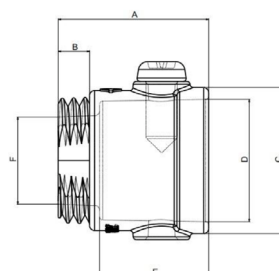

TAPAS - SIN PINTURA

	CÓDIGO	DESCRIPCIÓN	MEDIDA	CANT. EMB.
	E011122012	CIEGA	3/4" y 1"	24
	E011122032	CIEGA	1,1/4"	24
	E011022162	PARA UN ENCHUFE REDONDO	3/4" y 1"	24
	E011022322	PARA UN ENCHUFE REDONDO	1,1/4"	24
	E011022122	PARA UN INTERRUPTOR VERTICAL	3/4" y 1"	24
	E011022282	PARA UN INTERRUPTOR VERTICAL	1,1/4"	24
	E011022132	PARA DOS INTERRUPTORES HORIZONTALES JUNTOS	3/4" y 1"	24
	E011022292	PARA DOS INTERRUPTORES HORIZONTALES JUNTOS	1,1/4"	24

* Acompaña 2 tornillos

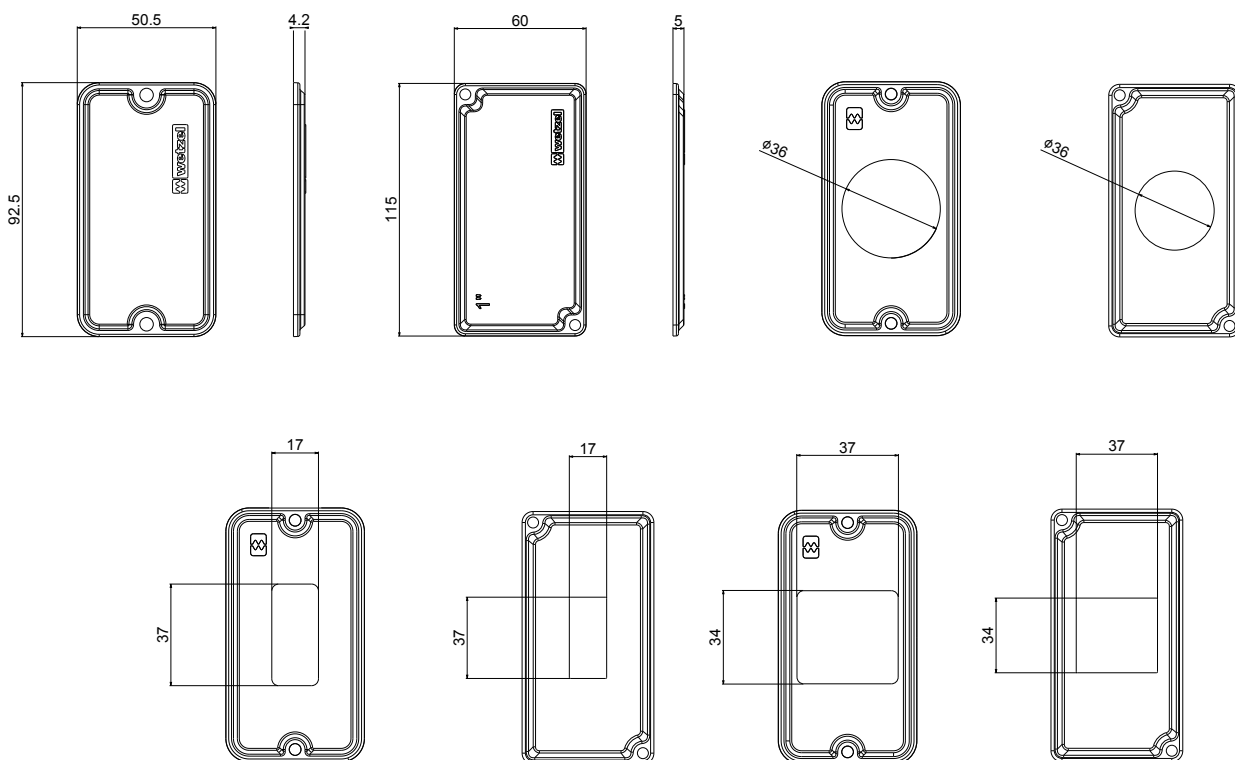

CAJA MÚLTIPLE POLIWETZEL CON PINTURA

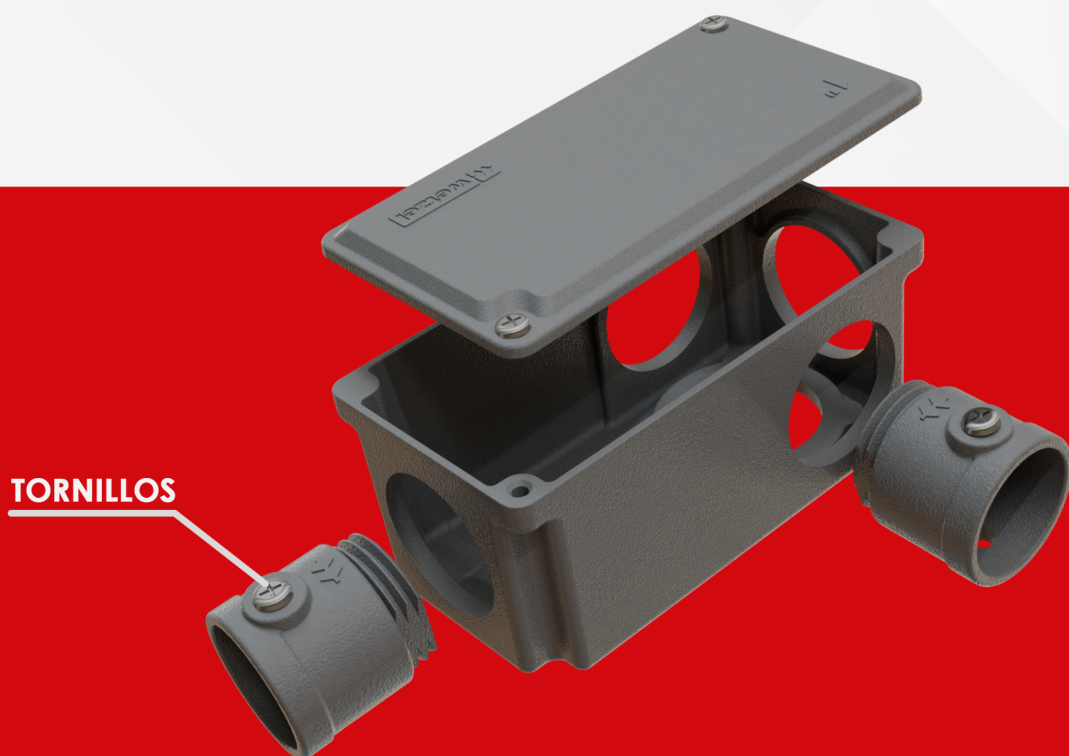

CONOZCA MÁS SOBRE

MODELOS

- DISPONIBLE EN MODELO L (LPW) y X (XPW)



LPW



XPW

DIFERENTE ALTURA EN EL CALIBRE 3/4"

- GARANTIZA MÁS VOLUMEN INTERNO;
- PRACTICIDAD EN LA INSTALACIÓN Y PASO DE CABLES, EVITANDO APLASTAMIENTOS Y REDUCIENDO RIESGOS DE CORTOCIRCUITOS ELÉCTRICOS;



OTROS

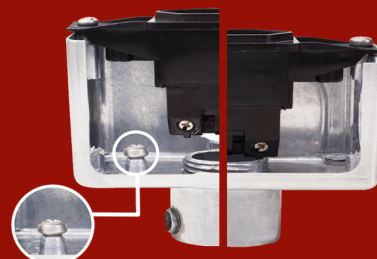

- CON TORNILLO PARA PUNTO DE ATERRAMIENTO

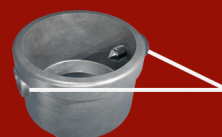





- CON 2 PUNTOS DE FIJACIÓN







CAJA MÚLTIPLE POLIWETZEL - CON PINTURA

CUERPO Y 1 TORNILLO PARA ATERRAMIENTO

	CÓDIGO	MODELO	MEDIDA	CANT. EMB.	DIMENSIONES (mm)	A	B	C	D	E
	E002312031	L	3/4"	12		92,5	48	20	50,5	19
	E002312041	L	1"	12		92,5	48	20	50,5	19
	E002312051	L	1,1/4"	12		115	50	25	60	28,5
	E002412031	X	3/4"	12		92,5	48	20	50,5	-
	E002412041	X	1"	12		92,5	48	20	50,5	-
	E002412051	X	1,1/4"	12		115	50	25	60	-

CAJA MÚLTIPLE POLIWETZEL - CON PINTURA

CUERPO CON 3 TAPONES Y 1 TORNILLO PARA ATERRAMIENTO

	CÓDIGO	MODELO	MEDIDA	CANT. EMB.	DIMENSIONES (mm)	A	B	C	D	E
	E002302031	L	3/4"	12		92,5	48	20	50,5	19
	E002302041	L	1"	12		92,5	48	20	50,5	19
	E002302051	L	1,1/4"	12		115	50	25	60	28,5
	E002402031	X	3/4"	12		92,5	48	20	50,5	-
	E002402041	X	1"	12		92,5	48	20	50,5	-
	E002402051	X	1,1/4"	12		115	50	25	60	-

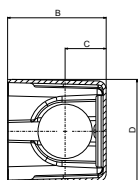

MODELO L

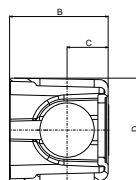
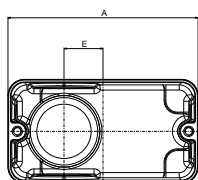



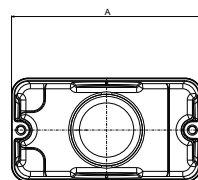



MODELO X



CAJA MÚLTIPLE POLIWETZEL - CON PINTURA

MONTADA - CAJA, TAPA, 3 TAPONES, TORNILLOS Y ATERRAMIENTO

	CÓDIGO	MODELO	MEDIDA	CANT. EMB.	DIMENSIONES (mm)	A	B	C	D	E
	E002302030	L	3/4"	12		92,5	52,2	20	50,5	19
	E002302040	L	1"	12		92,5	52,2	20	50,5	19
	E002302050	L	1.1/4"	12		115	55	25	60	28,5
	E002302060	L	1.1/2"	12		143	76,5	32,5	80	31,5
	E002302070	L	2"	12		160	90,5	42,5	90	35
	E002402030	X	3/4"	12		92,5	52,2	20	50,5	-
	E002402040	X	1"	12		92,5	52,2	20	50,5	-
	E002402050	X	1.1/4"	12		115	55	25	60	-
	E002402060	X	1.1/2"	12		143	76,5	32,5	80	-
	E002402070	X	2"	12	160	90,5	42,5	90	-	

* Acompaña 2 tornillos en la tapa y 1 en la punto de aterramiento

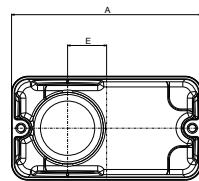
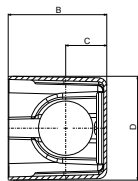



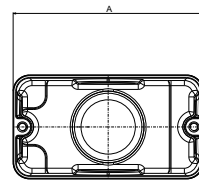
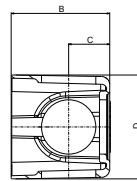

MODELO L



MODELO X

CONECTOR PARA CAJA MÚLTIPLE - CON PINTURA

SIN ROSCA

	CÓDIGO	mm	MEDIDA	CANT. EMB.	DIMENSIONES (mm)	A	B	C	D	E	F
	E001132030	19,05 mm	3/4"	30		24	5	24	20,1	17,4	14,3
	E001132040	25,4 mm	1"	30		26	6	31,8	26,4	18,2	20
	E001132050	31,75 mm	1.1/4"	20		28,5	6	39	33,2	20,2	25,4
	E001132060	38,10 mm	1.1/2"	10		32	6	43,1	39,3	24	34,5
	E001132070	50,8 mm	2"	10		43	8,2	57	51,7	32,5	48

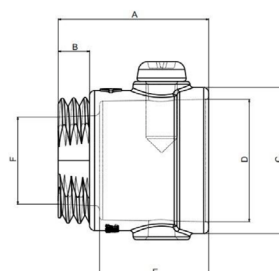

TAPAS - CON PINTURA

	CÓDIGO	DESCRIPCIÓN	MEDIDA	CANT. EMB.
	E011102012	CIEGA	3/4" y 1"	24
	E011102032	CIEGA	1,1/4"	24
	E011002162	PARA UN ENCHUFE REDONDO	3/4" y 1"	24
	E011002322	PARA UN ENCHUFE REDONDO	1,1/4"	24
	E011002122	PARA UN INTERRUPTOR VERTICAL	3/4" y 1"	24
	E011002282	PARA UN INTERRUPTOR VERTICAL	1,1/4"	24
	E011002132	PARA DOS INTERRUPTORES HORIZONTALES JUNTOS	3/4" y 1"	24
	E011002292	PARA DOS INTERRUPTORES HORIZONTALES JUNTOS	1,1/4"	24

* Acompaña 2 tornillos

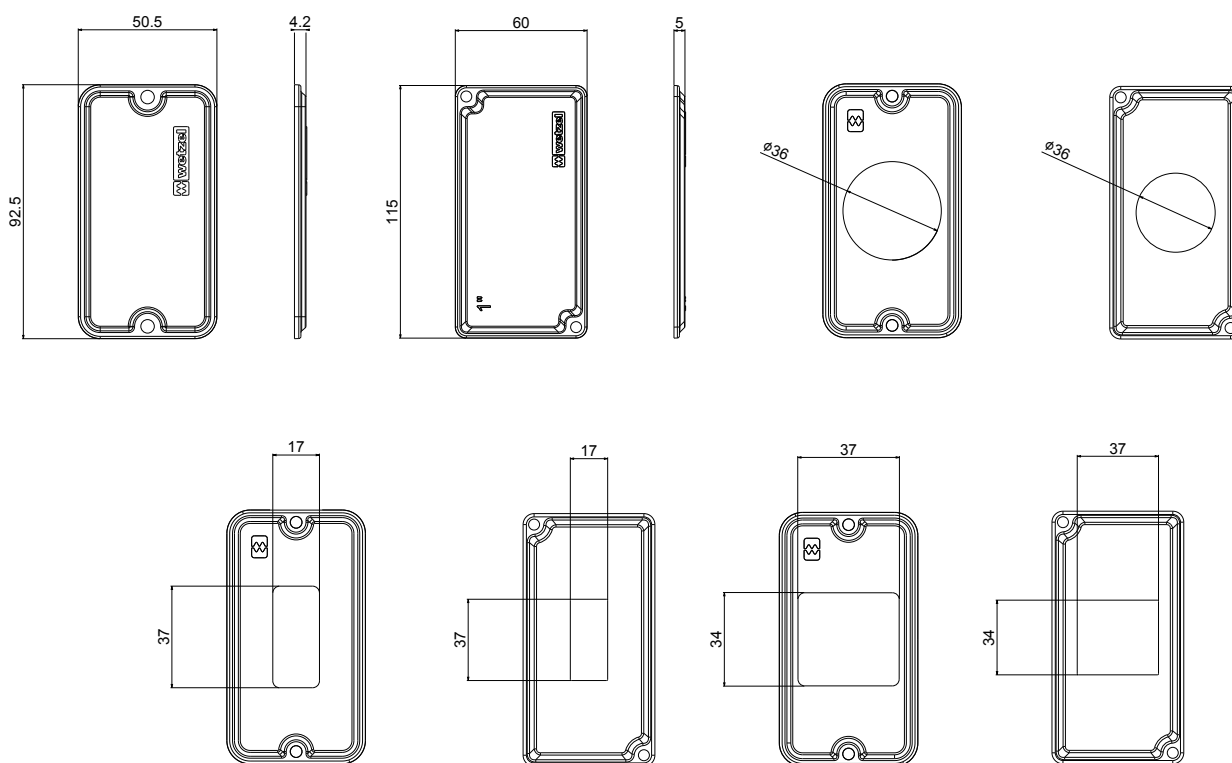

CAJA
BASTIDOR
(PORTA PLAQUETA)

PLATA - SIN PINTURA -CON PINTURA

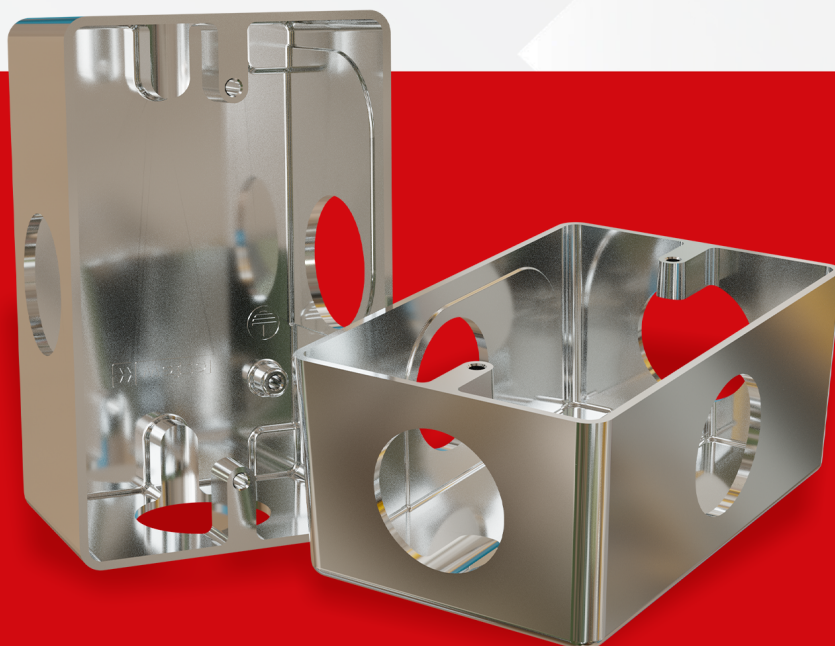

CONOZCA MÁS SOBRE

• DISPONIBLE EN COLORES:

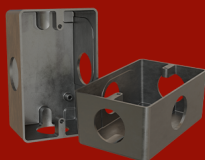

SIN PINTURA

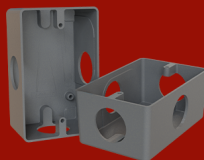

CON PINTURA
GRIS MUNSELL 6.5



PLATA





• CON TORNILLO PARA
PUNTO DE ATERRAMIENTO



CAJA MÚLTIPLE BASTIDOR - PLATA

CUERPO

MODELO X



	CÓDIGO	MEDIDA	CANT. EMB.	DIMENSIONES (mm)	A	B	C	D	E
	E002750031	3/4"	4		72	114	48,5	22	83,5
	E002750041	1"	4		72	114	48,5	22	83,5
	E002750051	1.1/4"	4		72	114	48,5	25	83,5

* Acompaña 2 tornillos para tapa y 1 en la punto de aterramiento

CAJA MÚLTIPLE BASTIDOR - SIN PINTURA

CUERPO

MODELO X



	CÓDIGO	MEDIDA	CANT. EMB.	DIMENSIONES (mm)	A	B	C	D	E
	E002550031	3/4"	4		72	114	48,5	22	83,5
	E002550041	1"	4		72	114	48,5	22	83,5
	E002550051	1.1/4"	4		72	114	48,5	25	83,5

* Acompaña 2 tornillos para tapa y 1 en la punto de aterramiento

CAJA MÚLTIPLE BASTIDOR - CON PINTURA

CUERPO

MODELO X

	CÓDIGO	MEDIDA	CANT. EMB.	DIMENSIONES (mm)	A	B	C	D	E
	E002350031	3/4"	4		72	114	48,5	22	83,5
	E002350041	1"	4		72	114	48,5	22	83,5
	E002350051	1.1/4"	4		72	114	48,5	25	83,5

* Acompaña 2 tornillos para tapa y 1 en la punto de aterramiento

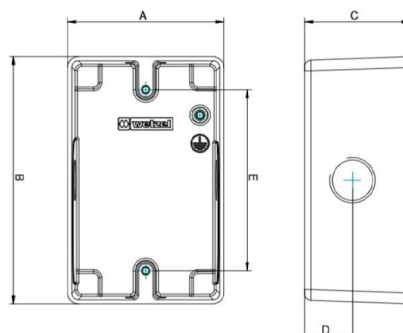

ACCESORIOS

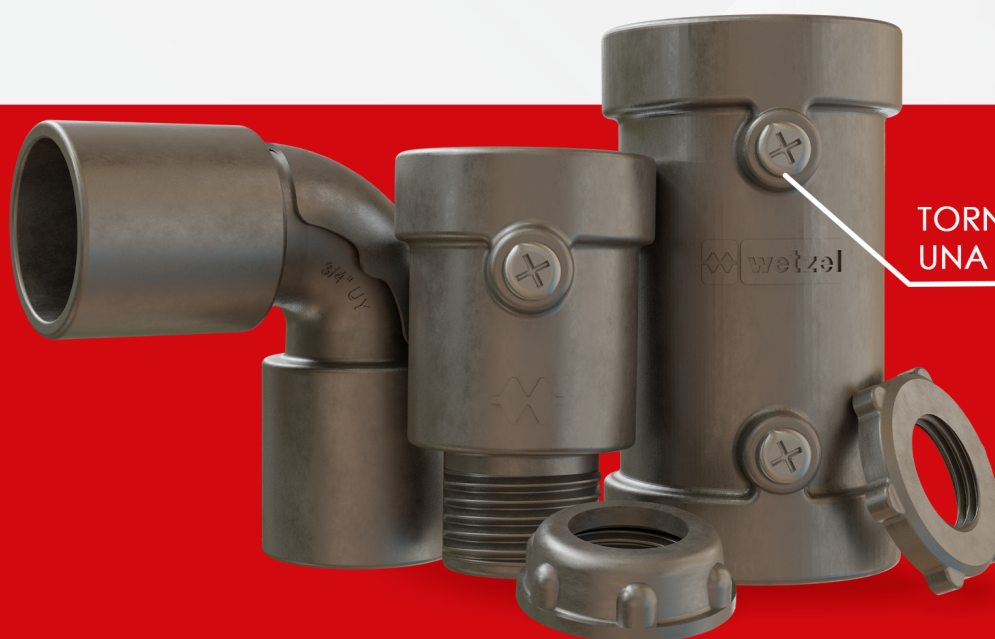

TORNILLOS PARA
UNA MEJOR FIJACIÓN

CONOZCA MÁS SOBRE

LÍNEA PROFESIONAL

- + RESISTENCIA PARA INSTALACIONES PROFESIONALES
- + ROBUSTEZ
- ✓ MÁS LARGO
- ✓ MÁS PESADO
- ✓ MÁS HILO

LÍNEA PRÁCTICA

- + PRACTICIDAD PARA INSTALACIONES DE PESO LIGERO
- + ECONOMÍA



VENTANA DE ALUMINIO
QUE GARANTIZA DURABILIDAD
Y EFICACIA



✓ AJUSTE A PRESIÓN

CODO



CONECTOR RECTO LARGO - PLATA

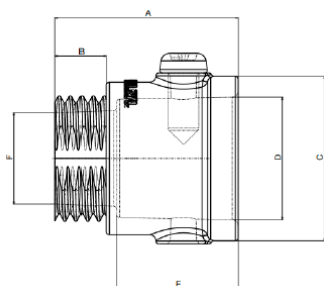

LÍNEA PROFESIONAL

	CÓDIGO	mm	MEDIDA	CANT. EMB.	DIMENSIONES (mm)	A	B	ØC	ØD	E	ØF
	E001072030	19,05 mm	3/4"	20		47	14	29,6	20,1	29,5	14,5
	E001072040	25,4 mm	1"	20		50	14,9	35,7	26,7	33,4	20,2
	E001072050	31,75 mm	1.1/4"	20		55	16	43,3	33,3	37	25,4



CONECTOR RECTO LARGO - PLATA

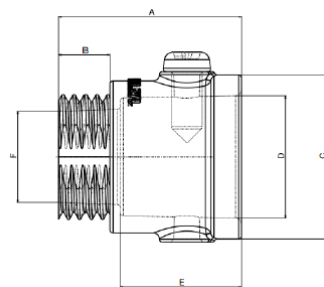

LÍNEA PRÁCTICA

	CÓDIGO	mm	MEDIDA	CANT. EMB.	DIMENSIONES (mm)	A	B	ØC	ØD	E	ØF
	E001082030	19,05 mm	3/4"	20		30	8,3	27	20,1	20	15
	E001082040	25,4 mm	1"	20		33	11	31	27	20	20
	E001082050	31,75 mm	1.1/4"	20		36	11	38,5	34	23,6	25,5



CONECTOR RECTO LARGO - SIN PINTURA

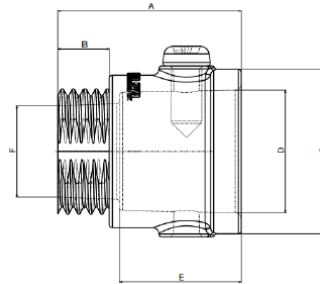

LÍNEA PROFESIONAL

	CÓDIGO	mm	MEDIDA	CANT. EMB.	DIMENSIONES (mm)	A	B	ØC	ØD	E	ØF
	E001052030	19,05 mm	3/4"	20		47	14	29,6	20,1	29,5	14,5
	E001052040	25,4 mm	1"	20		50	14,9	35,7	26,7	33,4	20,2
	E001052050	31,75 mm	1,1/4"	20		55	16	43,3	33,3	37	25,4



CONECTOR RECTO LARGO - SIN PINTURA

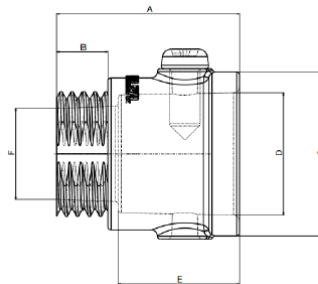

LÍNEA PRÁCTICA

	CÓDIGO	mm	MEDIDA	CANT. EMB.	DIMENSIONES (mm)	A	B	ØC	ØD	E	ØF
	E001062030	19,05 mm	3/4"	20		30	8,3	27	20,1	20	15
	E001062040	25,4 mm	1"	20		33	11	31	27	20	20
	E001062050	31,75 mm	1,1/4"	20		36	11	38,5	34	23,6	25,5



EMPALME - PLATA

LÍNEA PROFESIONAL

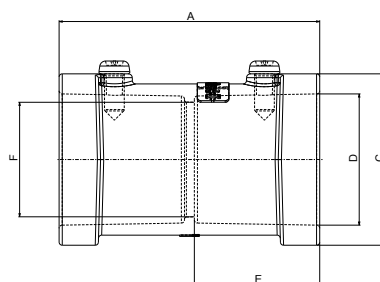

	CÓDIGO	MEDIDA	CANT. EMB.	DIMENSIONES (mm)	A	ØC	ØD	E	ØF
	E001102030	3/4"	20		55	29,8	20,8	26,2	19
	E001102040	1"	20		64	35,9	27,4	30,7	24
	E001102050	1.1/4"	20		66	43,4	33,8	31,7	31

* Abajo consulta



EMPALME - PLATA

LÍNEA PRÁCTICA

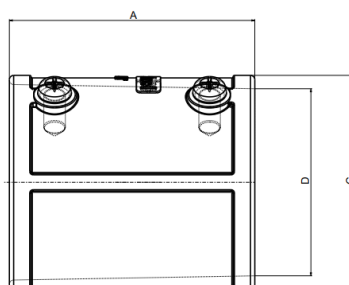

	CÓDIGO	MEDIDA	CANT. EMB.	DIMENSIONES (mm)	A	ØC	ØD
	E001112040	1"	20		46	31,5	26,5
	E001112050	1.1/4"	20		46,5	39	33,5

* Abajo consulta



EMPALME - SIN PINTURA

LÍNEA PROFESIONAL

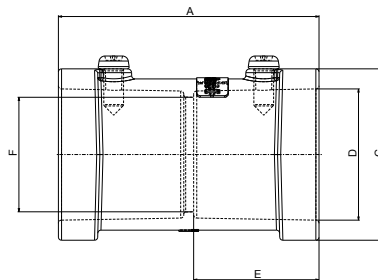

	CÓDIGO	MEDIDA	CANT. EMB.	DIMENSIONES (mm)	A	ØC	ØD	E	ØF
	E001102031	3/4"	20		55	29,8	20,8	26,2	19
	E001102041	1"	20		64	35,9	27,4	30,7	24
	E001102051	1.1/4"	20		66	43,4	33,8	31,7	31

* Abajo consulta



EMPALME - SIN PINTURA

LÍNEA PRÁCTICA

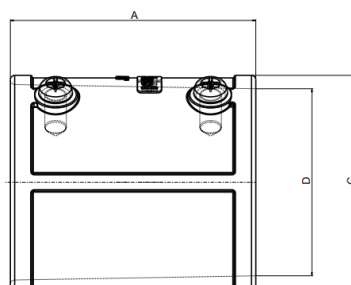

	CÓDIGO	MEDIDA	CANT. EMB.	DIMENSIONES (mm)	A	ØC	ØD
	E001112041	1"	20		46	31,5	26,5
	E001112051	1.1/4"	20		46,5	39	33,5

* Abajo consulta



CONECTOR RECTO BOX - SIN PINTURA

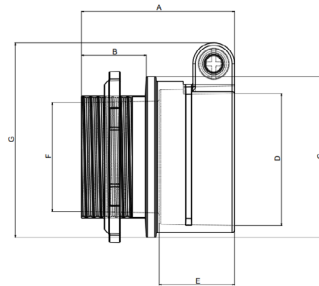

LÍNEA PROFESIONAL

	CÓDIGO	MEDIDA	CANT. EMB.	DIMENSIONES (mm)	A	B	ØC	ØD	E	ØF	G
	E001042030	3/4"	20		32,5	12	27	22	18	15,5	33,5
	E001042040	1"	20		33,7	12,5	32	27,1	18,5	20	39,7
	E001042050	1.1/4"	20		37	15	40	34,7	20	26,4	49





CODO - PLATA

TIPO BOLSA

	CÓDIGO	mm	MEDIDA	CANT. EMB.	DIMENSIONES (mm)	A	C	ØD	E
	E001032030	19,05 mm	3/4"	20		52,2	52,2	20,3	22,2
	E001032040	25,4 mm	1"	20		62,4	62,4	26,7	26,3
	E001032050	31,75 mm	1.1/4"	20		73,5	73,5	33,2	28,9







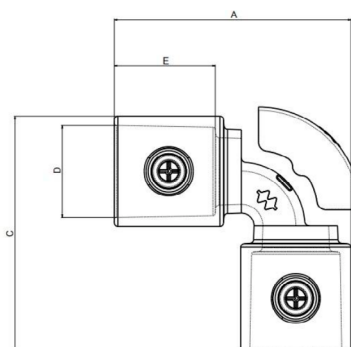

CODO - SIN PINTURA

TIPO BOLSA

	CÓDIGO	mm	MEDIDA	CANT. EMB.	DIMENSIONES (mm)	A	C	ØD	E
	E001022030	19,05 mm	3/4"	20		52,2	52,2	20,3	22,2
	E001022040	25,4 mm	1"	20		62,4	62,4	26,7	26,3
	E001022050	31,75 mm	1.1/4"	20		73,5	73,5	33,2	28,9







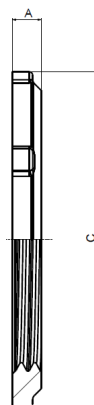



ARANDELA

	CÓDIGO	MEDIDA	CANT. EMB.	DIMENSIONES (mm)	
				A	ØC
	E001012021	1/2"	100	4	28,5
	E001012031	3/4"	100	4	28,5
	E001012041	1"	100	4,2	34
	E001012051	1.1/4"	100	4,5	42,5
	E001012061	1.1/2"	100	5	53
	E001012071	2"	100	5	58
	E001012081	2.1/2"	50	5,5	72
	E001012091	3"	20	6,5	86,5
	E001012111	4"	20	8	100,5



BOQUILLA

	CÓDIGO	MEDIDA	CANT. EMB.	DIMENSIONES (mm)		
				A	ØC	ØD
	E001022021	1/2"	100	7,5	25,5	12
	E001022031	3/4"	100	9	25,5	15
	E001022041	1"	100	9	31	20
	E001022051	1,1/4"	100	10	39	26,3
	E001022061	1,1/2"	100	11	48	32,5
	E001022071	2"	50	12,5	54,5	40
	E001022081	2,1/2"	25	13	66,5	52
	E001022091	3"	10	15,5	83,5	65
	E001022111	4"	10	16,5	97	77

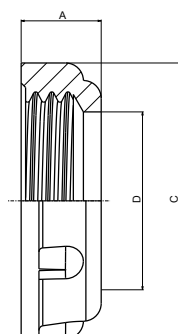

CAJA DE
PASE
SIN PINTURA - CON PINTURA

TORNILLOS
ORGANOMETÁLICO



TAPA REVERSIBLE
LISA Y ANTIDESLIZANTE

CONOZCA MÁS SOBRE



OPCIÓN DE CHASIS PARA FIJAR LOS COMPONENTES ELÉCTRICOS.

• SELLADO EN POLICLOROPRENO QUE OFRECE DE PROTECCIÓN ENTRE EL MONTAJE DEL CUERPO Y LA TAPA.



CON PUNTO DE ATERRAMIENTO

+ PROTECCION **IP65**



CAJA DE PASE - SIN PINTURA

TAPA REVERSIBLE - SIN CHASIS

	CÓDIGO	DESCRIPCIÓN	TAMAÑO	CANT. EMB.
	E007010013	CAJA DE PASE 1010-6 CON TAPA REVERSIBLE	10x10	4
	E007010026	CAJA DE PASE 1515-10 CON TAPA REVERSIBLE	15x15	3
	E007010038	CAJA DE PASE 2020-10 CON TAPA REVERSIBLE	20x20	2
	E007010042	CAJA DE PASE 3030-12 CON TAPA REVERSIBLE	30x30	1
	E007010312	CAJA DE PASE 4040-20 CON TAPA REVERSIBLE	40x40	1

TAPA LISA - SIN CHASIS

	CÓDIGO	DESCRIPCIÓN	TAMAÑO	CANT. EMB.
	E007010052	CAJA DE PASE 4020-20 CON TAPA LISA	40x20	1

TAPA ANTIDESLIZANTE - SIN CHASIS

	CÓDIGO	DESCRIPCIÓN	TAMAÑO	CANT. EMB.
	E007010102	CAJA DE PASE 4020-20 CON TAPA ANTIDESLIZANTE	40x20	1

* Acompaña tornillo en el punto de aterramiento.

* Diseño técnico disponible en esta página 42.

CAJA DE PASE - SIN PINTURA

TAPA REVERSIBLE - CON CHASIS

	CÓDIGO	DESCRIPCIÓN	TAMAÑO	CANT. EMB.
	E007012115	CAJA DE PASE 1010-6 CON CHASIS CON TAPA REVERSIBLE	10x10	4
	E007012125	CAJA DE PASE 1515-10 CON CHASIS CON TAPA REVERSIBLE	15x15	3
	E007012135	CAJA DE PASE 2020-10 CON CHASIS CON TAPA REVERSIBLE	20x20	2
	E007012145	CAJA DE PASE 3030-12 CON CHASIS CON TAPA REVERSIBLE	30x30	1
	E007012316	CAJA DE PASE 4040-20 CON CHASIS CON TAPA REVERSIBLE	40x40	1

TAPA LISA - CON CHASIS

	CÓDIGO	DESCRIPCIÓN	TAMAÑO	CANT. EMB.
	E007012155	CAJA DE PASE 4020-20 CON CHASIS CON TAPA LISA	40x20	1

TAPA ANTIDESLIZANTE - CON CHASIS

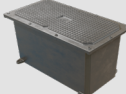
	CÓDIGO	DESCRIPCIÓN	TAMAÑO	CANT. EMB.
	E007012205	CAJA DE PASE 4020-20 CON CHASIS CON TAPA ANTIDESLIZANTE	40x20	1

* Acompaña tornillo en el punto de aterramiento.

* Diseño técnico disponible en esta página 42.

CAJA DE PASE - CON PINTURA

TAPA REVERSIBLE - SIN CHASIS

	CÓDIGO	DESCRIPCIÓN	TAMAÑO	CANT. EMB.
	E007012010	CAJA DE PASE CON PINTURA CON TAPA REVERSIBLE	10x10	4
	E007012020	CAJA DE PASE CON PINTURA CON TAPA REVERSIBLE	15x15	3
	E007012030	CAJA DE PASE CON PINTURA CON TAPA REVERSIBLE	20x20	2
	E007012040	CAJA DE PASE CON PINTURA CON TAPA REVERSIBLE	30x30	1
	E007012310	CAJA DE PASE CON PINTURA CON TAPA REVERSIBLE	40x40	1

TAPA LISA - SIN CHASIS

	CÓDIGO	DESCRIPCIÓN	TAMAÑO	CANT. EMB.
	E007012050	CAJA DE PASE CON PINTURA CON TAPA LISA	40x20	1

TAPA ANTIDESLIZANTE - SIN CHASIS

	CÓDIGO	DESCRIPCIÓN	TAMAÑO	CANT. EMB.
	E007012100	CAJA DE PASE CON PINTURA CON TAPA ANTIDESLIZANTE	40x20	1

* Acompaña tornillo en el punto de aterramiento.

* Diseño técnico disponible en esta página 42.

CAJA DE PASE - CON PINTURA

TAPA REVERSIBLE - CON CHASIS

	CÓDIGO	DESCRIPCIÓN	TAMAÑO	CANT. EMB.
	E007012110	CAJA DE PASE CON PINTURA CON CHASIS CON TAPA REVERSIBLE	10x10	4
	E007012120	CAJA DE PASE CON PINTURA CON CHASIS CON TAPA REVERSIBLE	15x15	3
	E007012130	CAJA DE PASE CON PINTURA CON CHASIS CON TAPA REVERSIBLE	20x20	2
	E007012140	CAJA DE PASE CON PINTURA CON CHASIS CON TAPA REVERSIBLE	30x30	1
	E007012311	CAJA DE PASE CON PINTURA CON CHASIS CON TAPA REVERSIBLE	40x40	1

TAPA LISA - CON CHASIS

	CÓDIGO	DESCRIPCIÓN	TAMAÑO	CANT. EMB.
	E007012150	CAJA DE PASE CON PINTURA CON CHASIS CON TAPA LISA	40x20	1

TAPA ANTIDESLIZANTE - CON CHASIS

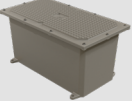
	CÓDIGO	DESCRIPCIÓN	TAMAÑO	CANT. EMB.
	E007012200	CAJA DE PASE CON PINTURA CON CHASIS CON TAPA ANTIDESLIZANTE	40x20	1

* Acompaña tornillo en el punto de aterramiento.

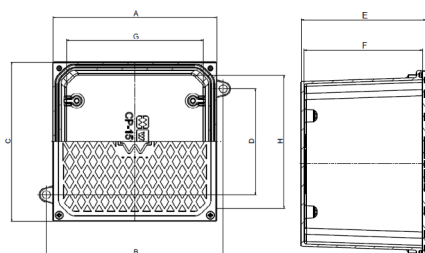

* Diseño técnico disponible en esta página 42.



DIMENSIONES (mm)

REFERENCIA	A	B	C	D	E	F	G	H
CP-1010	108	116	108	56	65,5	57,5	93	93
CP-1515	159	172	159	106	105,8	97,5	143	143
CP-2020	212	220	212	152	106	97,5	194	194
CP-3030	320	310	320	220	126	116	282	282
CP-4040	440	433	440	340	206,5	196	400	400
CP-4020	227	210	227	330	212	195	181	379

BAJO PEDIDO se puede proporcionar las cajas con agujero perforado.

DIÁMETRO(Ø) MÁXIMO DE AGUJEROS POR CARA (CUADRADA)			
REFERENCIA	 UNO	 DOS	 TRES
CP-1010	1"	3/4"	-
CP-1515	2"	1.1/4"	3/4"
CP-2020	2.1/2"	2"	1"
CP-3030	3"	2.1/2"	2"
CP-4040	4"	4"	3"

DIÁMETRO(Ø) MÁXIMO DE AGUJEROS POR CARA (RECTANGULAR)						
REFERENCIA	 UNO		 DOS		 TRES	
	LARGO	ANCHO	LARGO	ANCHO	LARGO	ANCHO
CP-4020	4"	2.1/2"	4"	2"	3"	1"

Disposicin de las Entradas

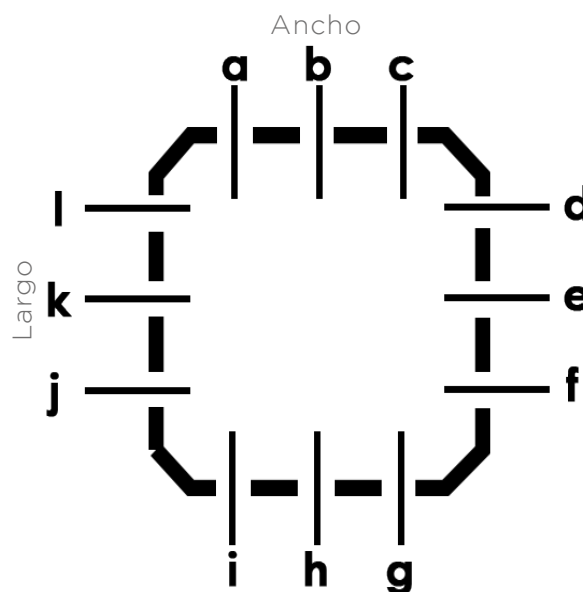

COMO SOLICITAR			
Código	E007010130		
Referencia	CP 2020-10 + TR CR ALU.		
Posiciones	"a" - 1"	"c" - 1"	"d" - 1"



*Para más informaciones, entre en contacto nuestro departamento comercial

CAJA
REDONDA
PLATA - SIN PINTURA - CON PINTURA



TORNILLOS
ORGANOMETÁLICO

CONOZCA MÁS SOBRE

• DISPONIBLE EN COLORES:

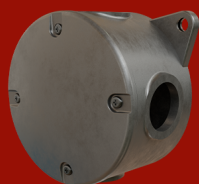

SIN PINTURA



CON PINTURA
GRIS MUNSELL 6.5

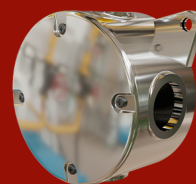

PLATA

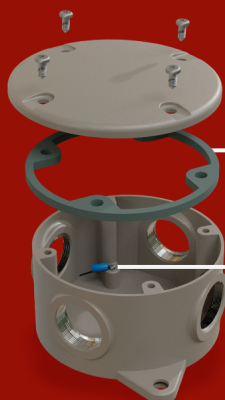

• SELLO DE ESTIRENO BUTADIENO

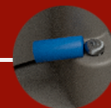



• PUNTO DE ATERRAMIENTO
(INCLUYE TERMINAL)





CAJA DE CONEXIÓN REDONDA PLATA

DIÁMETRO PEQUEÑO

	CÓDIGO	DESCRIPCIÓN	MEDIDA	CANT. EMB.
	E007032015	CAJA DE CONEXIÓN REDONDA, DIÁMETRO PEQUEÑO	3/4"	1
	E007032025	CAJA DE CONEXIÓN REDONDA, DIÁMETRO PEQUEÑO	1"	1



CAJA DE CONEXIÓN REDONDA SIN PINTURA

DIÁMETRO PEQUEÑO

	CÓDIGO	DESCRIPCIÓN	MEDIDA	CANT. EMB.
	E007032017	CAJA DE CONEXIÓN REDONDA, DIÁMETRO PEQUEÑO	3/4"	1
	E007032027	CAJA DE CONEXIÓN REDONDA, DIÁMETRO PEQUEÑO	1"	1

CAJA DE CONEXIÓN REDONDA CON PINTURA

DIÁMETRO PEQUEÑO

	CÓDIGO	DESCRIPCIÓN	MEDIDA	CANT. EMB.
	E007032010	CAJA DE CONEXIÓN REDONDA, DIÁMETRO PEQUEÑO	3/4"	1
	E007032020	CAJA DE CONEXIÓN REDONDA, DIÁMETRO PEQUEÑO	1"	1

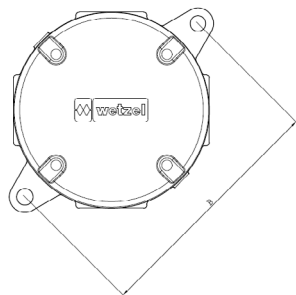
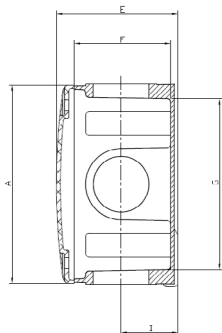

DIMENSIONES (mm)

MEDIDA	Ø A	B	E	F	Ø G	I
3/4"						
1"	95	110	54	43	78	22



CAJA DE CONEXIÓN REDONDA PLATA

DIÁMETRO MEDIO

	CÓDIGO	DESCRIPCIÓN	MEDIDA	CANT. EMB.
	E007030098	CAJA DE CONEXIÓN REDONDA, DIÁMETRO MEDIO	3/4"	1
	E007030088	CAJA DE CONEXIÓN REDONDA, DIÁMETRO MEDIO	1"	1
	E007032091	CAJA DE CONEXIÓN REDONDA, DIÁMETRO MEDIO	1.1/4"	1



CAJA DE CONEXIÓN REDONDA SIN PINTURA

DIÁMETRO MEDIO

	CÓDIGO	DESCRIPCIÓN	MEDIDA	CANT. EMB.
	E007032071	CAJA DE CONEXIÓN REDONDA, DIÁMETRO MEDIO	3/4"	1
	E007032081	CAJA DE CONEXIÓN REDONDA, DIÁMETRO MEDIO	1"	1
	E007032097	CAJA DE CONEXIÓN REDONDA, DIÁMETRO MEDIO	1.1/4"	1

CAJA DE CONEXIÓN REDONDA CON PINTURA

DIÁMETRO MEDIO

	CÓDIGO	DESCRIPCIÓN	MEDIDA	CANT. EMB.
	E007032095	CAJA DE CONEXIÓN REDONDA, DIÁMETRO MEDIO	3/4"	1
	E007032105	CAJA DE CONEXIÓN REDONDA, DIÁMETRO MEDIO	1"	1
	E007032115	CAJA DE CONEXIÓN REDONDA, DIÁMETRO MEDIO	1.1/4"	1

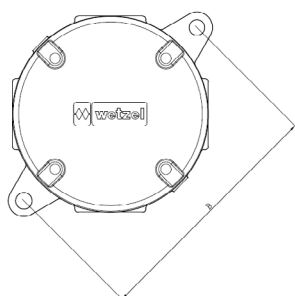
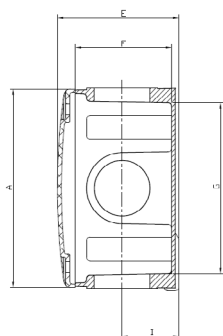

DIMENSIONES (mm)

MEDIDA	Ø A	B	E	F	Ø G	I
3/4"						
1"	105	115	56	38	86	25
1.1/4"						

CAJA
REFORZADA
CON PINTURA



TORNILLOS HEXAGONALES
EN ACERO INOXIDABLE

CONOZCA MÁS SOBRE

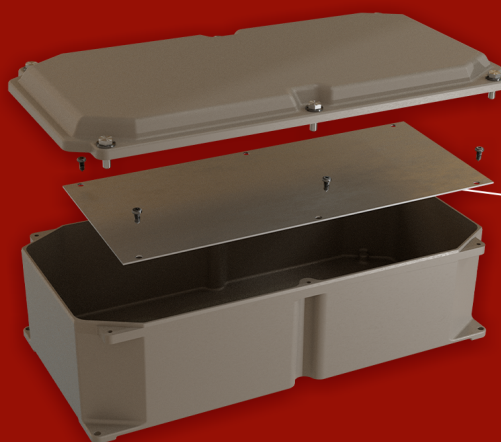

TORNILLO HEXAGONAL E
ARANDELA A PRESIÓN PARA
ASEGURAR UNA MAYOR FIJACIÓN

CHASIS PARA FIJACIÓN DE
COMPONENTES ELÉCTRICOS



CON PUNTO DE ATERRAMIENTO

+ PROTEÇÃO **IP65**



CAJA DE CONEXIÓN REFORZADA CON PINTURA

SIN CHASIS

	CÓDIGO	DESCRIPCIÓN	TAMAÑO	CANT. EMB.
	E007042010	CAJA DE CONEXIÓN SIN CHASIS REFORZADA	17x14	1
	E007042030	CAJA DE CONEXIÓN SIN CHASIS REFORZADA	28x14	1
	E007042040	CAJA DE CONEXIÓN SIN CHASIS REFORZADA	28x28	1
	E007042050	CAJA DE CONEXIÓN SIN CHASIS REFORZADA	34x14	1
	E007042020	CAJA DE CONEXIÓN SIN CHASIS REFORZADA	22x22	1
	E007042060	CAJA DE CONEXIÓN SIN CHASIS REFORZADA	34x28	1
	E007042070	CAJA DE CONEXIÓN SIN CHASIS REFORZADA	40x28	1
	E007042090	CAJA DE CONEXIÓN SIN CHASIS REFORZADA	45x28	1
	E007042100	CAJA DE CONEXIÓN SIN CHASIS REFORZADA	56x28	1
	E007042080	CAJA DE CONEXIÓN SIN CHASIS REFORZADA	40x35	1

CAJA DE CONEXIÓN REFORZADA CON PINTURA

CON CHASIS

	CÓDIGO	DESCRIPCIÓN	TAMAÑO	CANT. EMB.
	E007142010	CAJA DE CONEXIÓN CON CHASIS RETIRABLE REFORZADA	17x14	1
	E007142030	CAJA DE CONEXIÓN CON CHASIS RETIRABLE REFORZADA	28x14	1
	E007142040	CAJA DE CONEXIÓN CON CHASIS RETIRABLE REFORZADA	28x28	1
	E007142050	CAJA DE CONEXIÓN CON CHASIS RETIRABLE REFORZADA	34x14	1
	E007142020	CAJA DE CONEXIÓN CON CHASIS RETIRABLE REFORZADA	22x22	1
	E007142060	CAJA DE CONEXIÓN CON CHASIS RETIRABLE REFORZADA	34x28	1
	E007142070	CAJA DE CONEXIÓN CON CHASIS RETIRABLE REFORZADA	40x28	1
	E007142090	CAJA DE CONEXIÓN CON CHASIS RETIRABLE REFORZADA	45x28	1
	E007142100	CAJA DE CONEXIÓN CON CHASIS RETIRABLE REFORZADA	56x28	1
	E007142080	CAJA DE CONEXIÓN CON CHASIS RETIRABLE REFORZADA	40x35	1

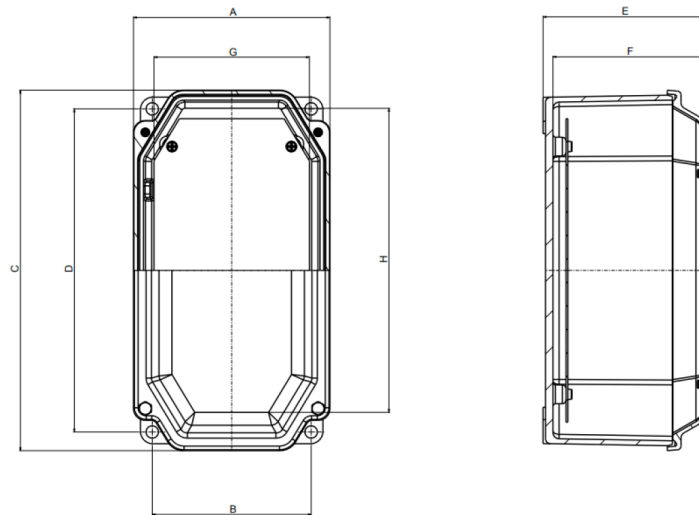

DIMENSIONES <small>(mm)</small>								
REFERÊNCIA	A	B	Ø C	Ø D	E	Ø F	G	H
CL-1714-12 ALU.	158	127,8	188	156,8	134	125	148	178
CL-2814-12 ALU.	158	127,8	291	260,8	134	125	148	281
CL-2828-12 ALU.	291	259,4	291	259,4	134	125	281	281
CL-3414-12 ALU.	158	127,8	357	326,8	134	125	148	347
CL-2222-16 ALU.	237	205,4	235	203,4	174	165	227	225
CL-3428-16 ALU.	291	258	358	325	174	165	281	348
CL-4028-16 ALU.	291	259,4	416	384,4	174	165	281	406
CL-4528-16 ALU.	291	259,4	461	430,8	174	165	281	451
CL-5628-16 ALU.	291	259,4	571	540,8	174	165	281	561
CL-4035-22 ALU.	369	335,3	416	382,3	174	225	359	406

BAJO PEDIDO se puede proporcionar las cajas con agujero perforado, siendo las opciones: Con rosca BSP o NPT.

REFERENCIA	DIÁMETRO(Ø) MÁXIMO DE AGUJEROS POR CARA (RECTANGULAR)					
	UNO		DOS		TRES	
	LARGO	ANCHO	LARGO	ANCHO	LARGO	ANCHO
CL-1714-12 ALU.	1.1/4"	1.1/2"	-	1/2"	-	-
CL-2814-12 ALU.	2"	1.1/2"	1.1/2"	1/2"	1"	-
CL-2828-12 ALU.	2"	2"	1.1/2"	1/2"	1"	1"
CL-3414-12 ALU.	2"	1.1/2"	2"	1/2"	1.1/2"	-
CL-2222-16 ALU.	2.1/2"	3"	1"	1.1/2"	1/2"	1"
CL-3428-16 ALU.	3"	3"	2.1/2"	3"	1.1/2"	1.1/4"
CL-4028-16 ALU.	3"	3"	3"	3"	2"	1.1/4"
CL-4528-16 ALU.	*	3"	3"	3"	-	1.1/4"
CL-5628-16 ALU.	*	3"	3"	3"	-	1.1/4"
CL-4035-22 ALU.	4"	4"	3"	4"	2"	2"

*Perforación desplazada. En las cajas CLPT 4528-16 y CLPT 5628-16 no habrá agujero en el centro de la caja, a lo largo.

CONOZCA NUESTRA LÍNEA



ACCESORIOS DE ALUMINIO



PLASTIK



ILUMINACIÓN LED



ILUMINACIÓN EX

VISÍTENOS Y DESCARGUE

Solicite su catálogo gratuitamente

+55 47 3451-8784

www.WETZEL.com.br





WETZEL.COM.BR