



2026

CATÁLOGO
DE PRODUTOS

Caixa de Derivação Múltipla
POLIWETZEL®





WETZEL S.A.

Fundada em 1932, em Joinville/SC, a Wetzel é referência nos segmentos em que atua, reconhecida pela capacidade de atender demandas específicas e de alto grau de exigência.

Com um portfólio amplo e diversificado, a empresa oferece soluções inovadoras e competitivas, desenvolvidas em parceria com seus clientes para garantir o melhor desempenho em projetos de elevada complexidade técnica.

Comprometida com a qualidade e a excelência, a Wetzel realiza investimentos constantes em tecnologia, processos e pessoas, assegurando eficiência e confiabilidade em cada etapa da produção.

Dinâmica e em permanente evolução, a empresa mantém atuação consolidada no mercado brasileiro e presença crescente no exterior, reforçando sua posição como referência em qualidade, inovação e confiança.

UNIDADES DE NEGÓCIOS

COMPONENTES PARA
INSTALAÇÕES **ELÉTRICAS**
E ILUMINAÇÃO INDUSTRIAL

COMPONENTES
AUTOMOTIVOS EM
ALUMÍNIO

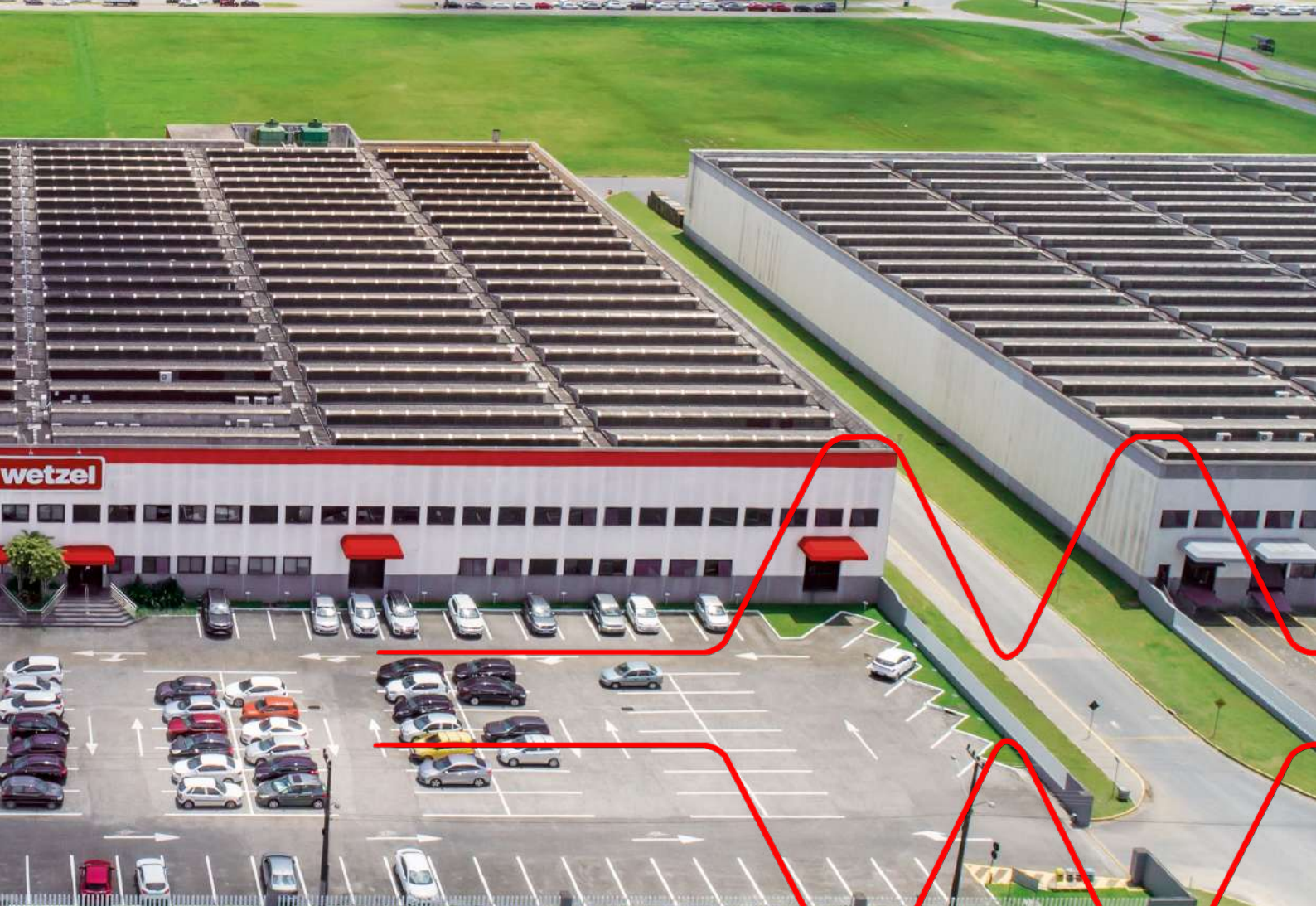

COMPONENTES PARA INSTALAÇÕES ELÉTRICAS INDUSTRIAIS

A Unidade Eletrotécnica desenvolve e fabrica componentes para instalações elétricas industriais, com foco nos segmentos de gerenciamento de cabos, iluminação industrial e produtos para áreas classificadas.

Seu portfólio reúne soluções completas para gerenciamento de cabos, disponíveis em alumínio e plástico, projetadas com alta qualidade, durabilidade e precisão dimensional.

Na área de iluminação industrial LED, a Wetzel alia décadas de experiência e liderança de mercado para oferecer uma linha diversificada, capaz de atender às exigências de todos os setores da indústria, da leve à pesada, garantindo eficiência energética, robustez e confiabilidade.

Os produtos para áreas classificadas são desenvolvidos conforme as certificações técnicas mais rigorosas, assegurando segurança, desempenho e conformidade em ambientes com risco de explosão.

Com engenharia especializada e processos produtivos de excelência, a Wetzel Eletrotécnica consolida-se como parceira estratégica da indústria na busca por soluções elétricas seguras, duráveis e de alta performance.

www.WETZEL.com.br

ÍNDICE

POLIWETZEL®





SEM PINTURA

-  **13** Combos
-  **19** Caixas
-  **20** Conectores
-  **22** Tampas Cegas
-  **22** Tampas Modulares
-  **23** Tampas Monoblocos

PRATA

-  **25** Combos
-  **31** Caixas
-  **32** Conectores
-  **34** Tampas Cegas
-  **34** Tampas Modulares
-  **35** Tampas Monoblocos

COM PINTURA

-  **37** Caixas
-  **38** Conectores
-  **40** Tampas Cegas
-  **40** Tampas Modulares
-  **41** Tampas Monoblocos

ACESSÓRIOS POLIWETZEL®

-  **43** Acessórios RJ
-  **43** Tampões
-  **44** Juntas de Vedação
-  **44** Anéis de Vedação
- 44** Kit de Vedação

LINHA INDUSTRIE

-  **45** Mecanismos Modulares

DESENHOS TÉCNICOS

- 47** Desenhos Técnicos

ENTENDA A ESTRUTURA DE PRODUTOS

As caixas de derivação com conexão móvel **WETZEL**, conhecidas como **POLIWETZEL®** ou condutores múltiplos, são essenciais para instalações elétricas aparentes.

Fabricadas tendo como referência a norma ABNT NBR 15701, oferecem diversas configurações para diferentes aplicações.

A escolha do produto depende, em grande parte, do ambiente em que será instalado.

Este catálogo refere-se exclusivamente às caixas de derivação da **CATEGORIA III (CONEXÃO MÓVEL)**.

As caixas das **CATEGORIAS I E II (CONEXÃO FIXA)**, conhecidas como **CONDULETZEL®**, não estão incluídas neste catálogo. Para mais informações, consulte o catálogo **CONDULETZEL®** - Caixas de Derivação Categorias I e II.

A seguir, apresentamos os critérios para selecionar a opção ideal para sua instalação elétrica aparente.

ACESSÓRIOS

Critério I: COMBOS POLIWETZEL®

Solução completa que inclui caixa de derivação com conexão móvel, tampões, conectores, tampa cega ou tampa modular, com mecanismos modulares, como interruptor(s) e tomada(s). Mais econômicos do que a soma dos componentes avulsos, estão disponíveis nas bitolas 3/4" e 1", versões X e L, com conectores sem rosca e tampões.

Critério II: ACABAMENTO DE SUPERFÍCIE

As caixas **POLIWETZEL®** estão disponíveis em três tipos de acabamento:

Prata: Polimento industrial que mantém a cor natural do alumínio, conferindo estética diferenciada e brilho sutil.

Com pintura: Cor cinza Munsell 6.5, com proteção superior contra corrosão, indicada para ambientes agressivos (poluição, umidade ou salinidade). Pintura eletrostática a pó de 25 micra, com acabamento uniforme. Nas Caixas Poliwetzel e Conectores Poliwetzel, a pintura é aplicada apenas na parte externa.

Sem pintura: Mantém a cor natural do alumínio, indicado para ambientes protegidos. Pode sofrer corrosão branca se exposto a condições agressivas, como salinidade, umidade ou ambientes industriais.

Todos os parafusos, tanto dos conectores quanto das tampas, possuem acabamento organometálico fosco, oferecendo resistência química superior aos parafusos "bicromatizados".

Critério III: TAMPAS

As tampas são disponibilizadas em três tipos:

Cegas: Utilizada para fechar completamente uma caixa de derivação, sem aberturas para interruptores ou tomadas.

Modulares: Contém três postos para mecanismos da linha INDUSTRIE WETZEL, como interruptores e tomadas, 100% compatíveis com encaixe dimensional e segurança. Elas dispensam a variedade de tampas necessárias quando utilizados os mecanismos monoblocos.

Convencionais: Para mecanismos monoblocos, compatíveis com a linha **POLIWETZEL®**, fornecidas separadamente.

Adquirir caixas já montadas com tampas cegas ou modulares é mais vantajoso do que comprar componentes avulsos.

Critério IV: CAIXAS COM TAMPAS

Até 1": podem ser fornecidas com tampas cegas ou modulares.

Acima de 1": fornecidas apenas com tampas cegas.

As caixas múltiplas **POLIWETZEL**® não são fornecidas com tampas convencionais para mecanismos monoblocos.

Critério V: BITOLAS

A bitola do conector **POLIWETZEL**® deve corresponder à bitola do eletroduto.

A bitola do eletroduto depende da espessura e quantidade de cabos, conforme **NBR 5410**.

Bitolas disponíveis (em polegadas): **1/2"**, **3/4"**, **1"**, **1.1/4"**, **1.1/2"**, **2"**, **2.1/2"**, **3"** e **4"**.

A seguir, confira a tabela de bitolas dos eletrodutos compatíveis com cada caixa.

CAIXAS COMPARTILHADAS

Cada conector possui sua bitola correspondente a bitola do eletroduto e conseqüentemente também da caixa, porém em algumas bitolas as caixas são compartilhadas conforme ilustrações abaixo.

Os conectores de 1/2" e 3/4" utilizam a mesma caixa:

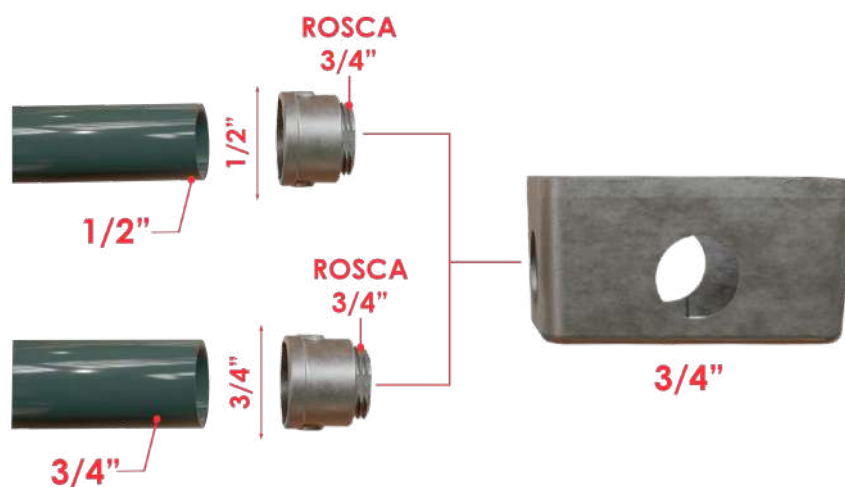

CAIXA DE DERIVAÇÃO MÚLTIPLA POLIWETZEL®

Os conectores de 1.1/4" e 1.1/2" utilizam a mesma caixa:



Os conectores de 2.1/2" e 3" utilizam a mesma caixa:

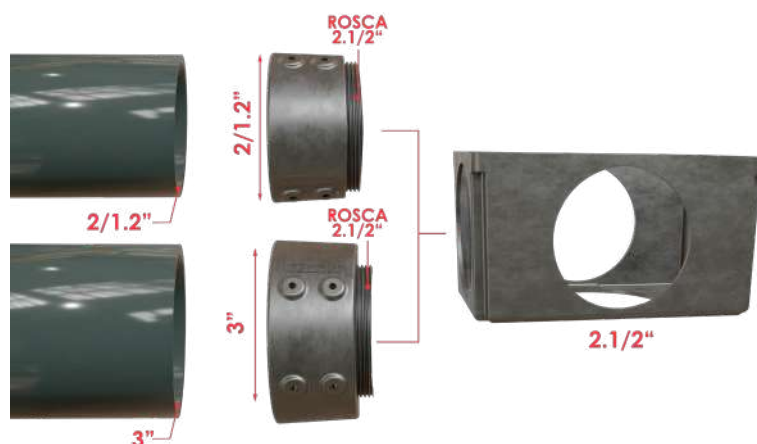

Critério VI: SEM ROSCA OU COM ROSCA

Após escolher o acabamento de superfície mais adequado à instalação, é necessário definir a forma de fixação do eletroduto na caixa de derivação. O eletroduto é fixado no conector, que por sua vez, é fixado na caixa. A fixação do eletroduto no conector pode ser feita por meio de rosca ou aperto com parafuso.

Sem rosca: Sistema mais utilizado, o eletroduto é fixado no conector por aperto com parafuso. Os conectores estão disponíveis nos três acabamentos do Critério II.

Com rosca (Sob consulta): Indicado para fixação e vedação mais rígida, pois garante maior firmeza na união do eletroduto com o conector. Os conectores com rosca são fornecidos apenas sob consulta.

Para instalação rígida com garantia IP54/65, consulte **CONDULETZEL®** - Conduletes Categoria II - Conexão Fixa com Rosca.



Critério VII: VEDAÇÃO

Para garantir a estanqueidade do conjunto, é necessário utilizar vedações na tampa, na união dos conectores com a caixa e nos tampões.

O sistema sem rosca requer vedações externas adicionais na união do eletroduto com os conectores.

Vedações fornecidas avulsas ou em kits (páginas 44).

Caixas de derivação de conexão móvel com conectores sem rosca são recomendadas para ambientes internos não sujeitos à ação de poeira, líquidos ou lavagem. Para ambientes externos (desabrigados) ou internos sujeitos a esses agentes, a utilização de vedações em todo o conjunto (caixa, tampa, conectores e tampões) é obrigatória.

Para soluções de instalação rígida com vedação e garantia de IP54/65, consulte o catálogo **CONDULETZEL®** - Conduletes Categoria II - Conexão Fixa com Rosca.

GRAU DE PROTEÇÃO - IP

Ingress Protection



São medidas aplicadas ao invólucro de um equipamento elétrico, definida pela NORMA **ABNT NBR IEC 60529**.

	0	1	2	3	4	5	6	7	8	9	
	Não protegido	Protegido contra quedas verticais de gotas d'água	Protegido contra quedas verticais de gotas d'água para uma inclinação máxima de 15 graus	Protegido contra água aspergida de um ângulo de ± 60 graus	Protegido contra projeções de água	Protegido contra jatos d'água	Protegido contra jatos potentes de água	Protegido contra imersão temporária	Protegido contra submersão	Protegido contra jatos d'água com alta pressão e temperatura.	
Não protegido	0	IP00	IP01	IP02							
Protegido contra objetos sólidos com \varnothing maior que 50mm	1	IP10	IP11	IP12							
Protegido contra objetos sólidos com \varnothing maior que 12mm	2	IP20	IP21	IP22	IP23						
Protegido contra objetos sólidos com \varnothing maior que 2,5mm	3	IP30	IP31	IP32	IP33	IP34					
Protegido contra objetos sólidos com \varnothing maior que 1mm	4	IP40	IP41	IP42	IP43	IP44	IP45	IP46			
Protegido contra poeira depressão: 200mm de coluna d'água Máxima aspiração de ar: 80 vezes o volume do invólucro	5					IP54	IP55	IP56			
Totalmente protegido contra a poeira. Mesmo procedimento de teste	6						IP65	IP66	IP67	IP68	IP69

Critério VIII: TIPOS

Existem dois tipos básicos (formatos) de caixas de derivação de conexão móvel: X e L. Cada um desses formatos, em conjunto com os conectores, possibilita a montagem de até oito configurações diferentes.

Em geral, os formatos necessários para cada instalação são especificados em projeto.



MODELO **L**
LPW

C



CONTINUOUS
(CONTINUA)

LR



L RIGHT
(L PARA DIREITA)

LB



L BACK
(L PARA TRÁS)

LL



L LEFT
(L PARA ESQUERDA)

E



END
(FINAL)

T



T
(FORMATO EM T)

TB



T BACK
(T PARA TRÁS)

X



X
(FORMATO EM X)



MODELO **X**
XPW

C



CONTINUOUS
(CONTINUA)

LR



L RIGHT
(L PARA DIREITA)

LB



L BACK
(L PARA TRÁS)

LL



L LEFT
(L PARA ESQUERDA)

E



END
(FINAL)

T



T
(FORMATO EM T)

TB



T BACK
(T PARA TRÁS)

X



X
(FORMATO EM X)

No caso de dúvidas, os consultores WETZEL estão à disposição nos canais de atendimento abaixo:

+55 47 3451-8784
www.WETZEL.com.br

COMBOS POLIWETZEL®

ALUMÍNIO SEM PINTURA

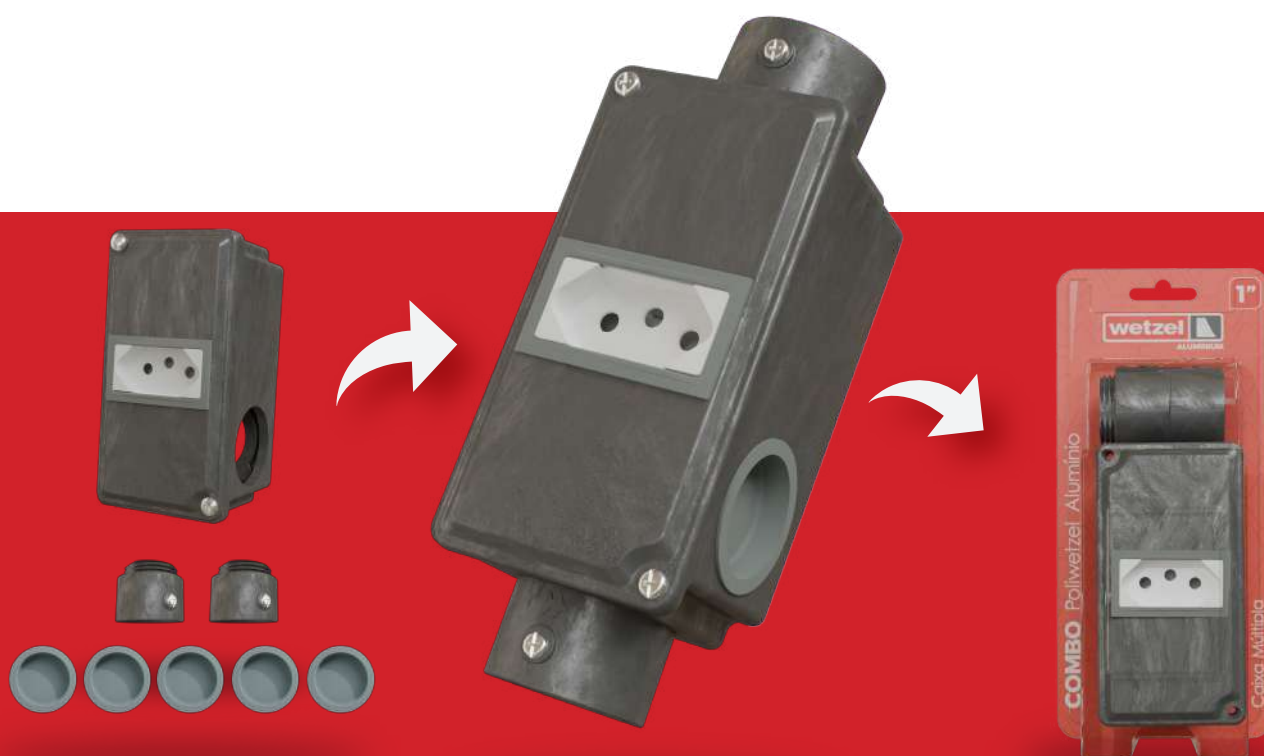

CONHEÇA OS COMBOS

- DISPONÍVEL NAS BITOLAS 3/4" E 1";
- MODELOS L (LPW) E X (XPW);
- SOLUÇÃO COMPLETA COM MECANISMOS MODULARES;
- PRÁTICO PARA ARMAZENAR E PREPARAR INSTALAÇÕES.



L (LPW)



X (XPW)







COMBO POLIWETZEL® ALUMÍNIO - SEM PINTURA

CAIXA DE DERIVAÇÃO COM 2 CONECTORES, 4 TAMPÕES, 2 PARAFUSOS







COM TAMPA CEGA

	DESCRIÇÃO	MODELO	BITOLA	CÓDIGO	QT. MÚLTIPLA
	TAMPA CEGA	L	3/4"	E002500140	12
			1"	E002500110	
		X	3/4"	E002600140	
			1"	E002600110	

TAMPA MODULAR - SEM MECANISMOS





















	DESCRIÇÃO	MODELO	BITOLA	CÓDIGO	QT. MÚLTIPLA
	TAMPA UM POSTO SEM MÓDULO	L	3/4"	E002500171	12
			1"	E002501171	
		X	3/4"	E002600171	
			1"	E002601171	
	TAMPA DOIS POSTOS SEM MÓDULO	L	3/4"	E002501172	12
			1"	E002501172	
		X	3/4"	E002601172	
			1"	E002601172	
	TAMPA TRÊS POSTOS SEM MÓDULO	L	3/4"	E002500173	12
			1"	E002501173	
		X	3/4"	E002600173	
			1"	E002601173	

COM 1 MECANISMO MODULAR













	DESCRIÇÃO	MODELO	BITOLA	CÓDIGO	QT. MÚLTIPLA
	UMA TOMADA 10A	L	3/4"	E002500174	12
			1"	E002500111	
		X	3/4"	E002600141	
			1"	E002600111	
	UMA TOMADA 20A	L	3/4"	E002500142	12
			1"	E002500175	
		X	3/4"	E002600142	
			1"	E002600112	
	UM INTERRUPTOR SIMPLES	L	3/4"	E002500143	12
			1"	E002500177	
		X	3/4"	E002600143	
			1"	E002600113	

COMBOS POLIWETZEL® SEM PINTURA



















COM 1 MECANISMO MODULAR

	DESCRIÇÃO	MODELO	BITOLA	CÓDIGO	QT. MÚLTIPLA
 	UMA TOMADA RJ45 CAT 5	L	3/4"	E002500144	12
			1"	E002500178	
 	UMA TOMADA RJ45 CAT 5	X	3/4"	E002600144	
			1"	E002600114	
 	UMA TOMADA RJ11	L	3/4"	E002500146	12
			1"	E002500119	
 	UMA TOMADA RJ11	X	3/4"	E002600146	
			1"	E002600119	
 	UM INTERRUPTOR PARALELO	L	3/4"	E002500147	12
			1"	E002500179	
 	UM INTERRUPTOR PARALELO	X	3/4"	E002600147	
			1"	E002600130	
 	UMA TOMADA RJ45 CAT 6	L	3/4"	E002501144	12
			1"	E002501114	
 	UMA TOMADA RJ45 CAT 6	X	3/4"	E002601144	
			1"	E002601114	
 	UMA TOMADA USB 5.0V 2.0A	L	3/4"	E002500170	12
			1"	E002501146	
 	UMA TOMADA USB 5.0V 2.0A	X	3/4"	E002600170	
			1"	E002601146	

COM 2 MECANISMOS MODULARES















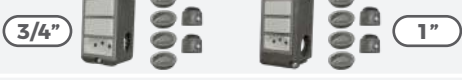
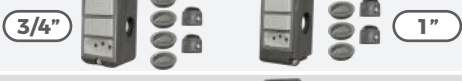

	DESCRIÇÃO	MODELO	BITOLA	CÓDIGO	QT. MÚLTIPLA
 	UMA TOMADA RJ45 CAT 5 + UMA TOMADA RJ11	L	3/4"	E002500145	12
			1"	E002500115	
 	UMA TOMADA RJ45 CAT 5 + UMA TOMADA RJ11	X	3/4"	E002600145	
			1"	E002600115	
 	DUAS TOMADAS 20A	L	3/4"	E002500148	12
			1"	E002500116	
 	DUAS TOMADAS 20A	X	3/4"	E002600148	
			1"	E002600116	
 	DOIS INTERRUPTORES SIMPLES	L	3/4"	E002500149	12
			1"	E002500117	
 	DOIS INTERRUPTORES SIMPLES	X	3/4"	E002600149	
			1"	E002600117	

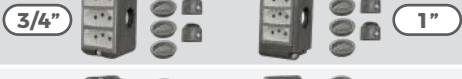
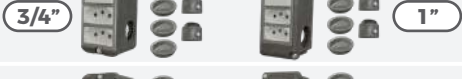

COM 2 MECANISMOS MODULARES					
	DESCRIÇÃO	MODELO	BITOLA	CÓDIGO	QT. MÚLTIPLA
	UM INTERRUPTOR SIMPLES + UMA TOMADA 20A	L	3/4"	E002500150	12
			1"	E002500118	
		X	3/4"	E002600150	
			1"	E002600118	
	DUAS TOMADAS 10A	L	3/4"	E002500155	12
			1"	E002500125	
		X	3/4"	E002600155	
			1"	E002600125	
	UM INTERRUPTOR SIMPLES + UMA TOMADA 10A	L	3/4"	E002500156	12
			1"	E002500126	
		X	3/4"	E002600156	
			1"	E002600126	
	DOIS INTERRUPTORES PARALELOS	L	3/4"	E002500160	12
			1"	E002500131	
		X	3/4"	E002600160	
			1"	E002600131	
	UM INTERRUPTOR PARALELO + UMA TOMADA 10A	L	3/4"	E002500161	12
			1"	E002500132	
		X	3/4"	E002600161	
			1"	E002600132	
	UM INTERRUPTOR PARALELO + UMA TOMADA 20A	L	3/4"	E002500162	12
			1"	E002500133	
		X	3/4"	E002600162	
			1"	E002600133	
	DUAS TOMADAS RJ45 CAT 5	L	3/4"	E002500168	12
			1"	E002501139	
		X	3/4"	E002600168	
			1"	E002601139	
	UMA TOMADA RJ45 CAT 6 + UMA TOMADA RJ11	L	1"	E002501115	12
		X		E002601115	12
	DUAS TOMADAS RJ45 CAT 6	L	1"	E002501139	12
		X		E002601139	12

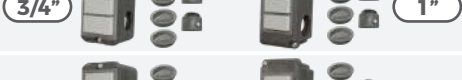









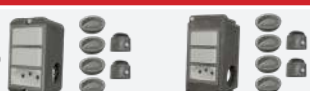





COMBOS POLIWETZEL® SEM PINTURA

COM 3 MECANISMOS MODULARES

	DESCRIÇÃO	MODELO	BITOLA	CÓDIGO	QT. MÚLTIPLA
	TRÊS TOMADAS 10A	L	3/4"	E002500151	12
		L	1"	E002500121	
	TRÊS TOMADAS 10A	X	3/4"	E002600151	
		X	1"	E002600121	
	TRÊS INTERRUPTORES SIMPLES	L	3/4"	E002500152	12
		L	1"	E002500122	
	TRÊS INTERRUPTORES SIMPLES	X	3/4"	E002600152	
		X	1"	E002600122	
	DUAS TOMADAS 10A + UM INTERRUPTOR SIMPLES	L	3/4"	E002500153	12
		L	1"	E002500123	
	DUAS TOMADAS 10A + UM INTERRUPTOR SIMPLES	X	3/4"	E002600153	
		X	1"	E002600123	
	DOIS INTERRUPTORES SIMPLES + UMA TOMADA 10A	L	3/4"	E002500154	12
		L	1"	E002500124	
	DOIS INTERRUPTORES SIMPLES + UMA TOMADA 10A	X	3/4"	E002600154	
		X	1"	E002600124	
	TRÊS TOMADAS 20A	L	3/4"	E002500157	12
		L	1"	E002500127	
	TRÊS TOMADAS 20A	X	3/4"	E002600157	
		X	1"	E002600127	
	DUAS TOMADAS 20A + UM INTERRUPTOR SIMPLES	L	3/4"	E002500158	12
		L	1"	E002500128	
	DUAS TOMADAS 20A + UM INTERRUPTOR SIMPLES	X	3/4"	E002600158	
		X	1"	E002600128	
	DOIS INTERRUPTORES SIMPLES + UMA TOMADA 20A	L	3/4"	E002500159	12
		L	1"	E002500129	
	DOIS INTERRUPTORES SIMPLES + UMA TOMADA 20A	X	3/4"	E002600159	
		X	1"	E002600129	
	TRÊS INTERRUPTORES PARALELOS	L	3/4"	E002500163	12
		L	1"	E002500134	
	TRÊS INTERRUPTORES PARALELOS	X	3/4"	E002600163	
		X	1"	E002600134	
	DUAS TOMADAS 10A + UM INTERRUPTOR PARALELO	L	3/4"	E002500164	12
		L	1"	E002500135	
	DUAS TOMADAS 10A + UM INTERRUPTOR PARALELO	X	3/4"	E002600164	
		X	1"	E002600135	

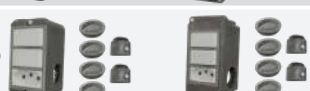

COM 3 MECANISMOS MODULARES

	DESCRIÇÃO	MODELO	BITOLA	CÓDIGO	QT. MÚLTIPLA
  	DOIS INTERRUPTORES PARALELOS + UMA TOMADA 10A	L	3/4"	E002500165	12
			1"	E002500136	
  	DOIS INTERRUPTORES PARALELOS + UMA TOMADA 10A	X	3/4"	E002600165	
			1"	E002600136	
  	DUAS TOMADAS 20A + UM INTERRUPTOR PARALELO	L	3/4"	E002500166	12
			1"	E002500137	
  	DUAS TOMADAS 20A + UM INTERRUPTOR PARALELO	X	3/4"	E002600166	
			1"	E002600137	
  	DOIS INTERRUPTORES PARALELOS + UMA TOMADA 20A	L	3/4"	E002500167	12
			1"	E002500138	
  	DOIS INTERRUPTORES PARALELOS + UMA TOMADA 20A	X	3/4"	E002600167	
			1"	E002600138	

POLIWETZEL[®]

ALUMÍNIO SEM PINTURA

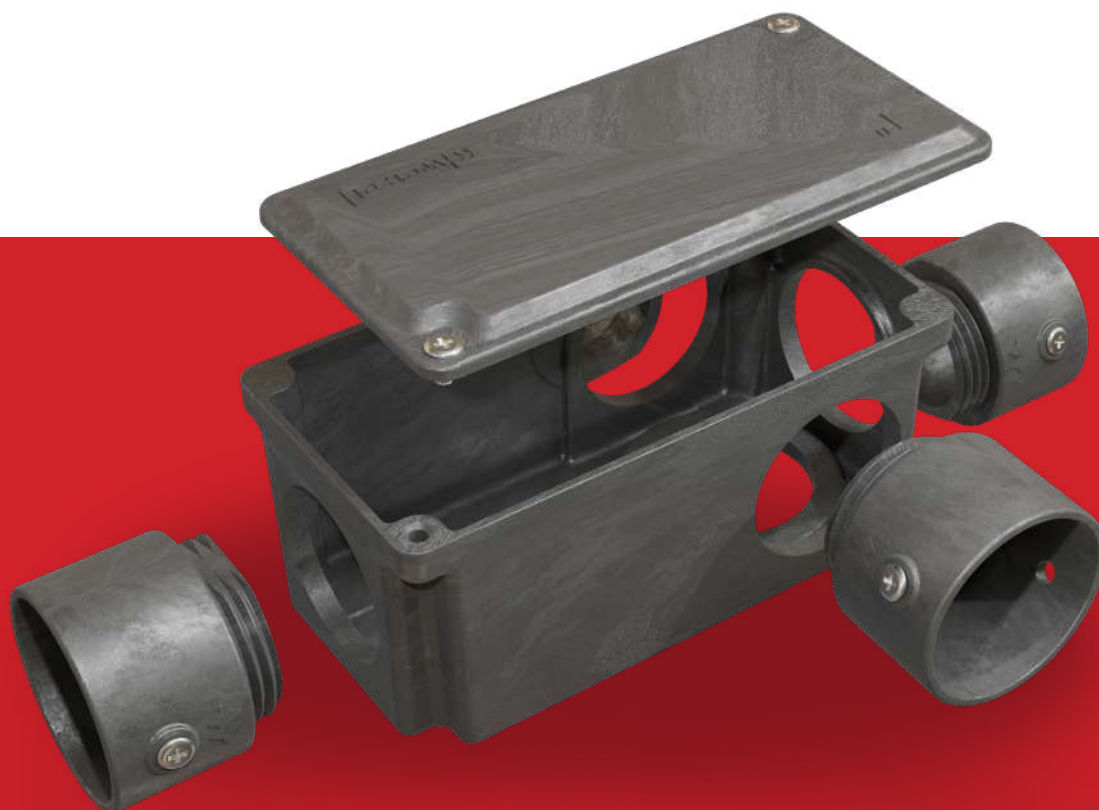

CONHEÇA MAIS SOBRE

- DISPONÍVEL NAS BITOLAS 1,2", 3/4" E 1";
- MODELOS L (LPW) E X (XPW);
- POSSUI PONTO DE ATERRAMENTO NBR 15701.



L (LPW)



X (XPW)



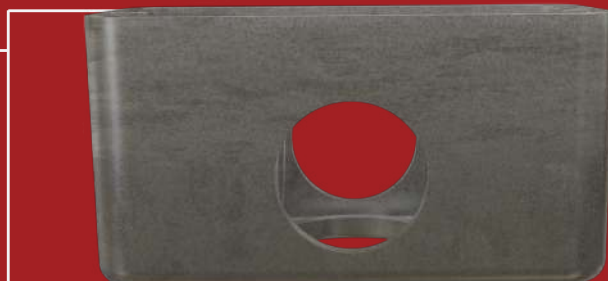

ALTURA DIFERENCIADA NA BITOLA 3/4" ●

PRATICIDADE NA INSTALAÇÃO E NA PASSAGEM DOS CABOS, QUE EVITA O ESMAGAMENTO E REDUZ RISCOS DE CURTOS CIRCUITOS ELÉTRICOS





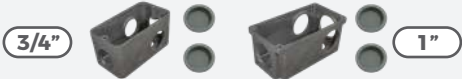

CAIXA DE DERIVAÇÃO MÚLTIPLA POLIWETZEL® - SEM PINTURA

SEM TAMPA

	DESCRIÇÃO	MODELO	BITOLA	CÓDIGO	QT. MÚLTIPLA
	CORPO	L	1/2" E 3/4"	E002510031	12
		X	1"	E002510041	
	CORPO	L	1/2" E 3/4"	E002610031	
		X	1"	E002610041	
	CORPO E 2 TAMPÕES	L	1/2" E 3/4"	E002500031	12
		X	1"	E002500041	
	CORPO E 2 TAMPÕES	L	1/2" E 3/4"	E002600031	
		X	1"	E002600041	

COM TAMPA CEGA

	DESCRIÇÃO	MODELO	BITOLA	CÓDIGO	QT. MÚLTIPLA
	CORPO COM TAMPA, 2 PARAFUSOS E 2 TAMPÕES	L	1/2" E 3/4"	E002500030	12
			1"	E002500040	
			1.1/4" E 1.1/2"	E002500050	4
		2"	E002500070	1	
		2.1/2" E 3"	E002500080		
		CORPO COM TAMPA, 2 PARAFUSOS E 2 TAMPÕES	X	1/2" E 3/4"	E002600030
	1"			E002600040	
1.1/4" E 1.1/2"	E002600050			4	
	2"		E002600070		1
	2.1/2" E 3"		E002600080		
	4"		E002600090	1	

COM TAMPA MODULAR

	DESCRIÇÃO	MODELO	BITOLA	CÓDIGO	QT. MÚLTIPLA
	CORPO COM TAMPA MODULAR 1 POSTO, 2 PARAFUSOS E 2 TAMPÕES	L	1/2" E 3/4"	E002500035	12
			1"	E002500045	
		X	1/2" E 3/4"	E002600035	
			1"	E002600045	
	CORPO COM TAMPA MODULAR 2 POSTOS, 2 PARAFUSOS E 2 TAMPÕES	L	1"	E002500046	12
		X	1"	E002600046	
	CORPO COM TAMPA MODULAR 3 POSTOS, 2 PARAFUSOS E 2 TAMPÕES	L	1/2" E 3/4"	E002500036	12
			1"	E002500047	
		X	1/2" E 3/4"	E002600036	
			1"	E002600047	

CONECTOR PARA POLIWETZEL® - SEM PINTURA

SEM ROSCA INTERNA

	DESCRIÇÃO	*BITOLA	CÓDIGO	QT. MÚTIPLA
	CONECTOR PARA POLIWETZEL SEM ROSCA INTERNA	1/2"	E001500020	40
		3/4"	E001500030	30
		1"	E001500040	20
		1.1/4"	E001500050	20
		1.1/2"	E001500060	20
		2"	E001500070	20
		2.1/2"	E001500080	4
		3"	E001500090	4
		4"	E001500110	4

COM ROSCA INTERNA (SOB CONSULTA)

	DESCRIÇÃO	*BITOLA	CÓDIGO	QT. MÚTIPLA
	CONECTOR PARA POLIWETZEL COM ROSCA INTERNA	1/2"	E001510020	40
		3/4"	E001510030	30
		1"	E001510040	20

*O conector possui sua bitola correspondente a bitola do eletroduto e conseqüentemente também da caixa, porém em algumas bitolas as caixas são compartilhadas conforme ilustrado nas páginas 7 e 8.

TAMPAS

CEGA - MODULAR - MONOBLOCO

ALUMÍNIO SEM PINTURA



CONHEÇA MAIS SOBRE

- DISPONÍVEL NAS BITOLAS 1,2", 3/4" E 1";
- ACOMPANHA PARAFUSOS ORGANOMETÁLICOS;
- O MODELO DE TAMPA MODULAR É COMPATÍVEL COM A LINHA INDUSTRIE.

LINHA INDUSTRIE







TAMPAS SEM PINTURA

TAMPAS CEGAS - SEM PINTURA

	DESCRIÇÃO	BITOLA	CÓDIGO	QT. MÚTIPLA
	CEGA	1/2" e 3/4"	E011120012	36
		1"	E011120032	

TAMPAS PARA MECANISMOS MODULARES - SEM PINTURA

	DESCRIÇÃO	BITOLA	CÓDIGO	QT. MÚTIPLA
	PARA UM MÓDULO VERTICAL	1/2" e 3/4"	E011020522	12
	PARA UM MÓDULO HORIZONTAL	1"	E011020692	12
	PARA DOIS MÓDULOS HORIZONTAIS	1"	E011020702	12
	PARA TRÊS MÓDULOS HORIZONTAIS	1/2" e 3/4"	E011020532	12
		1"	E011020722	

TAMPAS PARA MECANISMOS MODULARES | TOMADAS RJ - SEM PINTURA

	DESCRIÇÃO	BITOLA	CÓDIGO	QT. MÚTIPLA
	PARA UMA TOMADA RJ 45	1/2" e 3/4"	E011020523	12
		1"	E011020693	
	PARA DUAS TOMADAS RJ 45	1/2" e 3/4"	E011020533	12
		1"	E011020703	
	COM UMA TOMADA RJ 45	1/2" e 3/4"	E011020525	12
		1"	E011020695	
	COM DUAS TOMADAS RJ 45	1/2" e 3/4"	E011020535	12
		1"	E011020705	

LINHA INDUSTRIE

MECANISMOS MODULARES

MÓDULOS WETZEL
ESPECIALMENTE DESENVOLVIDOS PARA AS
TAMPAS MODULARES.

Disponível na página 45



TAMPAS PARA MECANISMOS MONOBLOCOS - SEM PINTURA

	DESCRIÇÃO	BITOLA	CÓDIGO	QT. MÚTIPLA
	PARA DUAS TOMADAS HEXAGONAIS HORIZONTAIS SEPARADAS	1/2" e 3/4"	E011020362	36
	PARA UM INTERRUPTOR VERTICAL	1/2" e 3/4"	E011020122	36
		1"	E011020282	
	PARA DOIS INTERRUPTORES HORIZONTAIS JUNTOS	1/2" e 3/4"	E011020132	36
		1"	E011020292	
	PARA TRÊS INTERRUPTORES HORIZONTAIS JUNTOS	1/2" e 3/4"	E011020142	36
		1"	E011020302	
	PARA DOIS INTERRUPTORES HORIZONTAIS SEPARADOS	1/2" e 3/4"	E011020152	36
		1"	E011020312	
	PARA UMA TOMADA REDONDA	1/2" e 3/4"	E011020162	36
		1"	E011020322	
	PARA UMA TOMADA HEXAGONAL VERTICAL	1/2" e 3/4"	E011022814	36
		1"	E011022815	

TAMPAS PARA TOMADAS RJ - SEM PINTURA

	DESCRIÇÃO	BITOLA	CÓDIGO	QT. MÚTIPLA
	PARA UMA TOMADA RJ SEM MOLDURA	1/2" e 3/4"	E011022502	36
		1"	E011022712	
	PARA DUAS TOMADAS RJ SEM MOLDURA	1/2" e 3/4"	E011022802	36
		1"	E011022602	
	PARA UMA TOMADA RJ COM MOLDURA	1/2" e 3/4"	E011022503	36
		1"	E011022713	
	PARA DUAS TOMADAS RJ COM MOLDURAS	1/2" e 3/4"	E011022803	36
		1"	E011022603	

COMBOS POLIWETZEL[®]

ALUMÍNIO PRATA



DISPONIBILIDADE SOB CONSULTA

CONHEÇA OS COMBOS

- DISPONÍVEL NAS BITOLAS 3/4" E 1";
- MODELOS L (LPW) E X (XPW);
- SOLUÇÃO COMPLETA COM MECANISMOS MODULARES;
- PRÁTICO PARA ARMAZENAR E PREPARAR INSTALAÇÕES.



L (LPW)





X (XPW)





COMBO POLIWETZEL® ALUMÍNIO - PRATA

CAIXA DE DERIVAÇÃO COM 2 CONECTORES, 4 TAMPÕES, 2 PARAFUSOS



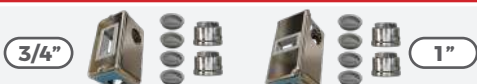



COM TAMPA CEGA

	DESCRIÇÃO	MODELO	BITOLA	CÓDIGO	QT. MÚLTIPLA
	TAMPA CEGA	L	3/4"	E002700140	12
			1"	E002700110	
		X	3/4"	E002800140	
			1"	E002800110	

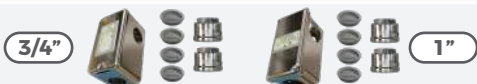
TAMPA MODULAR - SEM MECANISMOS



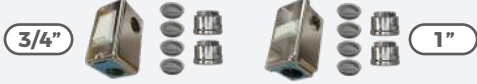





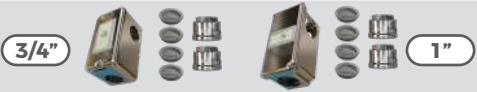

	DESCRIÇÃO	MODELO	BITOLA	CÓDIGO	QT. MÚLTIPLA		
	TAMPA UM POSTO SEM MÓDULO	L	3/4"	E002700171	12		
			1"	E002701171			
		X	3/4"	E002800171			
			1"	E002801171			
	TAMPA DOIS POSTOS SEM MÓDULO	L	1"	E002701172	12		
			X	1"		E002801172	
		TAMPA TRÊS POSTOS SEM MÓDULO		L		3/4"	E002700173
			X			3/4"	E002800173
	L			1"	E002701173		
			X	1"	E002801173		

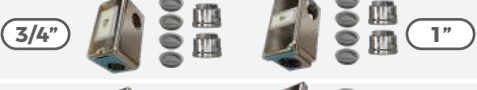
COM 1 MECANISMO MODULAR

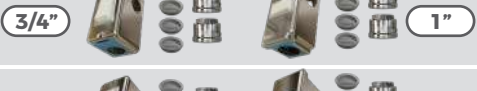



	DESCRIÇÃO	MODELO	BITOLA	CÓDIGO	QT. MÚLTIPLA
	UMA TOMADA 10A	L	3/4"	E002700141	12
			1"	E002700111	
		X	3/4"	E002800141	
			1"	E002800111	
	UMA TOMADA 20A	L	3/4"	E002700142	12
			X	3/4"	
		L		1"	
			X	1"	
	UM INTERRUPTOR SIMPLES	L		3/4"	E002700143
			X	3/4"	E002800143
		L		1"	E002700113
			X	1"	E002800113

COMBOS POLIWETZEL® PRATA



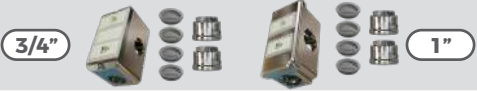
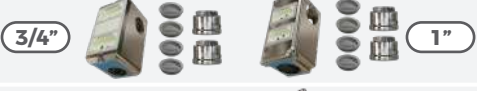







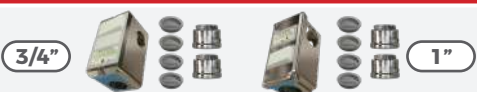



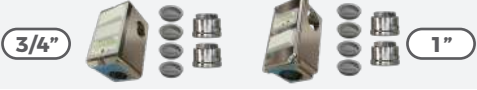

COM 1 MECANISMO MODULAR

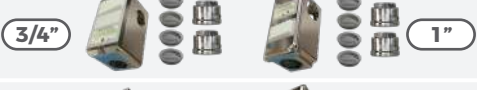
	DESCRIÇÃO	MODELO	BITOLA	CÓDIGO	QT. MÚLTIPLA
	UMA TOMADA RJ45 CAT 5	L	3/4"	E002700144	12
			1"	E002700114	
		X	3/4"	E002800144	
			1"	E002800114	
	UMA TOMADA RJ11	L	3/4"	E002700146	12
			1"	E002700119	
		X	3/4"	E002800146	
			1"	E002800119	
	UM INTERRUPTOR PARALELO	L	3/4"	E002700147	12
			1"	E002700130	
		X	3/4"	E002800147	
			1"	E002800130	
	UMA TOMADA RJ45 CAT 6	L	3/4"	E002701144	12
			1"	E002701114	
		X	3/4"	E002801144	
			1"	E002801114	
	UMA TOMADA USB 5.0V 2.0A	L	3/4"	E002700170	12
			1"	E002701146	
		X	3/4"	E002800170	
			1"	E002801146	

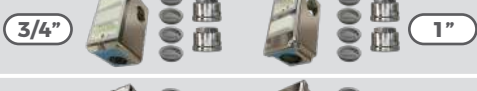
COM 2 MECANISMOS MODULARES

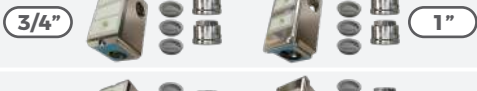
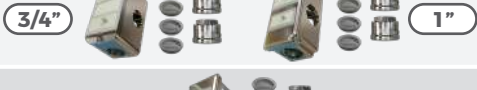







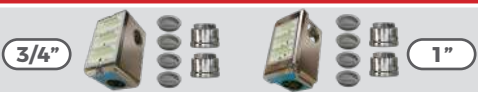

	DESCRIÇÃO	MODELO	BITOLA	CÓDIGO	QT. MÚLTIPLA
	UMA TOMADA RJ45 CAT 5 + UMA TOMADA RJ11	L	3/4"	E002700145	12
			1"	E002700115	
		X	3/4"	E002800145	
			1"	E002800115	
	DUAS TOMADAS 20A	L	3/4"	E002700148	12
			1"	E002700116	
		X	3/4"	E002800148	
			1"	E002800116	
	DOIS INTERRUPTORES SIMPLES	L	3/4"	E002700149	12
			1"	E002700117	
		X	3/4"	E002800149	
			1"	E002800117	

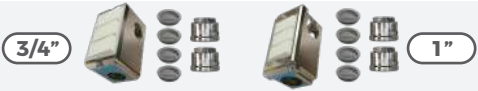
COM 2 MECANISMOS MODULARES

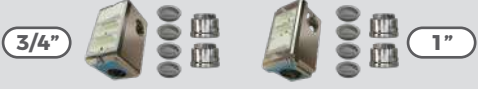
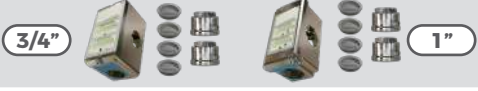
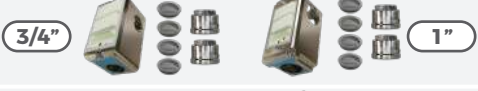
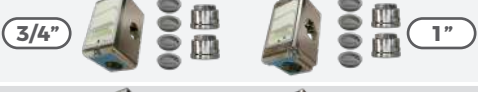

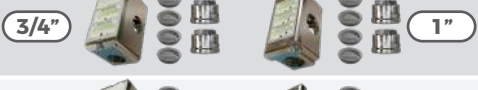
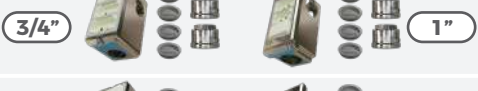
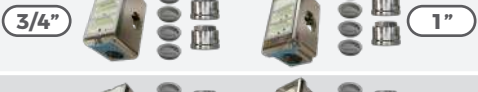

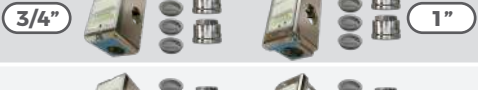
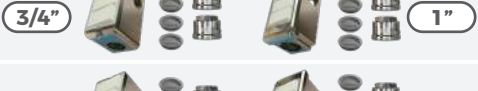
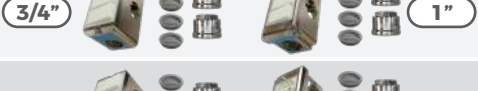
	DESCRIÇÃO	MODELO	BITOLA	CÓDIGO	QT. MÚLTIPLA
	UM INTERRUPTOR SIMPLES + UMA TOMADA 20A	L	3/4"	E002700150	12
		X	1"	E002700118	
				3/4"	
		1"		E002800118	
	DUAS TOMADAS 10A	L	3/4"	E002700155	12
		X	1"	E002700125	
				3/4"	
		1"		E002800125	
	UM INTERRUPTOR SIMPLES + UMA TOMADA 10A	L	3/4"	E002700156	12
		X	1"	E002700126	
				3/4"	
		1"		E002800126	
	DOIS INTERRUPTORES PARALELOS	L	3/4"	E002700160	12
		X	1"	E002700131	
				3/4"	
		1"		E002800131	
	UM INTERRUPTOR PARALELO + UMA TOMADA 10A	L	3/4"	E002700161	12
		X	1"	E002700132	
				3/4"	
		1"		E002800132	
	UM INTERRUPTOR PARALELO + UMA TOMADA 20A	L	3/4"	E002700162	12
		X	1"	E002700133	
				3/4"	
		1"		E002800133	
	DUAS TOMADAS RJ45 CAT 5	L	3/4"	E002700168	12
		X	1"	E002700139	
				3/4"	
		1"		E002800139	
	UMA TOMADA RJ45 CAT 6 + UMA TOMADA RJ11	L	1"	E002701115	12
		X		E002801115	12
	DUAS TOMADAS RJ45 CAT 6	L	1"	E002701139	12
		X		E002801139	12

COMBOS POLIWETZEL® PRATA

COM 3 MECANISMOS MODULARES

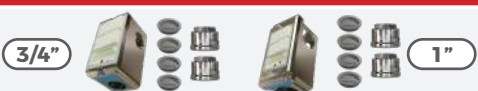
	DESCRIÇÃO	MODELO	BITOLA	CÓDIGO	QT. MÚLTIPLA
	TRÊS TOMADAS 10A	L	3/4"	E002700151	12
			1"	E002700121	
		X	3/4"	E002800151	
			1"	E002800121	
	TRÊS INTERRUPTORES SIMPLES	L	3/4"	E002700152	12
			1"	E002700122	
		X	3/4"	E002800152	
			1"	E002800122	
	DUAS TOMADAS 10A + UM INTERRUPTOR SIMPLES	L	3/4"	E002700153	12
			1"	E002700123	
		X	3/4"	E002800153	
			1"	E002800123	
	DOIS INTERRUPTORES SIMPLES + UMA TOMADA 10A	L	3/4"	E002700154	12
			1"	E002700124	
		X	3/4"	E002800154	
			1"	E002800124	
	TRÊS TOMADAS 20A	L	3/4"	E002700157	12
			1"	E002700127	
		X	3/4"	E002800157	
			1"	E002800127	
	DUAS TOMADAS 20A + UM INTERRUPTOR SIMPLES	L	3/4"	E002700158	12
			1"	E002700128	
		X	3/4"	E002800158	
			1"	E002800128	
	DOIS INTERRUPTORES SIMPLES + UMA TOMADA 20A	L	3/4"	E002700159	12
			1"	E002700129	
		X	3/4"	E002800159	
			1"	E002800129	
	TRÊS INTERRUPTORES PARALELOS	L	3/4"	E002700163	12
			1"	E002700134	
		X	3/4"	E002800163	
			1"	E002800134	
	DUAS TOMADAS 10A + UM INTERRUPTOR PARALELO	L	3/4"	E002700164	12
			1"	E002700135	
		X	3/4"	E002800164	
			1"	E002800135	

COM 3 MECANISMOS MODULARES

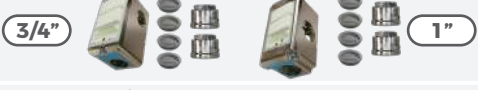
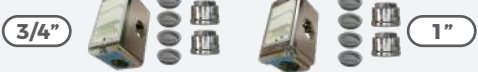
	DESCRIÇÃO	MODELO	BITOLA	CÓDIGO	QT. MÚLTIPLA
	DOIS INTERRUPTORES PARALELOS + UMA TOMADA 10A	L	3/4"	E002700165	12
			1"	E002700136	
		X	3/4"	E002800165	
			1"	E002800136	
	DUAS TOMADAS 20A + UM INTERRUPTOR PARALELO	L	3/4"	E002700166	12
			1"	E002700137	
		X	3/4"	E002800166	
			1"	E002800137	
	DOIS INTERRUPTORES PARALELOS + UMA TOMADA 20A	L	3/4"	E002700167	12
			1"	E002700138	
		X	3/4"	E002800167	
			1"	E002800138	

POLIWETZEL[®]

ALUMÍNIO PRATA

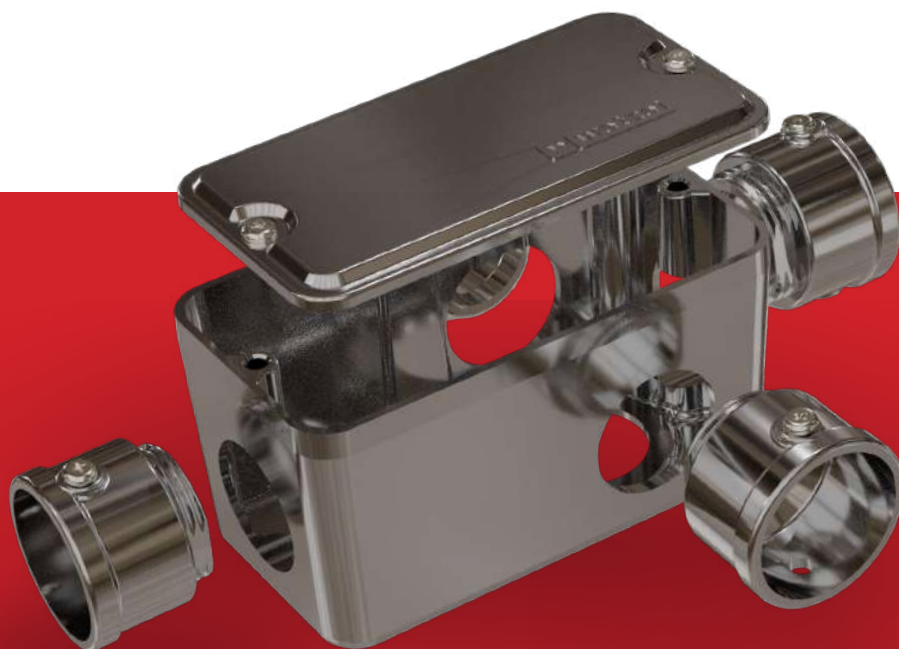

DISPONIBILIDADE SOB CONSULTA

CONHEÇA MAIS SOBRE

- DISPONÍVEL NAS BITOLAS 1,2", 3/4" E 1";
- MODELOS L (LPW) E X (XPW);
- POSSUI PONTO DE ATERRAMENTO NBR 15701.



L (LPW)



X (XPW)





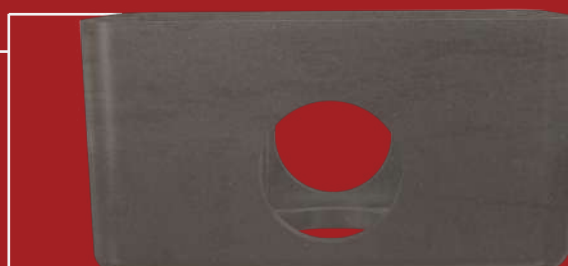



ALTURA DIFERENCIADA NA BITOLA 3/4"

PRATICIDADE NA INSTALAÇÃO E NA PASSAGEM DOS CABOS, QUE EVITA O ESMAGAMENTO E REDUZ RISCOS DE CURTOS CIRCUITOS ELÉTRICOS



CAIXA DE DERIVAÇÃO MÚLTIPLA POLIWETZEL® - PRATA

SEM TAMPA

	DESCRIÇÃO	MODELO	BITOLA	CÓDIGO	QT. MÚLTIPLA
 	CORPO	L	1/2" e 3/4"	E002710031	12
			1"	E002710041	
 	CORPO	X	1/2" e 3/4"	E002810031	
			1"	E002810041	
 	CORPO E 2 TAMPÕES	L	1/2" e 3/4"	E002700031	12
			1"	E002700041	
 	CORPO E 2 TAMPÕES	X	1/2" e 3/4"	E002800031	
			1"	E002800041	

COM TAMPA CEGA

	DESCRIÇÃO	MODELO	BITOLA	CÓDIGO	QT. MÚLTIPLA
 	CORPO COM TAMPA, 2 PARAFUSOS E 2 TAMPÕES	L	1/2" e 3/4"	E002700030	12
			1"	E002700040	
 			1.1/4" e 1.1/2"	E002700050	4
			2"	E002700070	
 		X	1/2" e 3/4"	E002800030	12
			1"	E002800040	
 			1.1/4" e 1.1/2"	E002800050	4
			2"	E002800070	

COM TAMPA MODULAR

	DESCRIÇÃO	MODELO	BITOLA	CÓDIGO	QT. MÚLTIPLA
 	CORPO COM TAMPA MODULAR 1 POSTO, 2 PARAFUSOS E 2 TAMPÕES	L	1/2" e 3/4"	E002700035	12
			1"	E002700045	
 		X	1/2" e 3/4"	E002800035	
			1"	E002800045	
 	CORPO COM TAMPA MODULAR 2 POSTOS, 2 PARAFUSOS E 2 TAMPÕES	L	1"	E002700046	12
 		X	1"	E002800046	
 	CORPO COM TAMPA MODULAR 3 POSTOS, 2 PARAFUSOS E 2 TAMPÕES	L	1/2" e 3/4"	E002700036	12
			1"	E002700047	
 		X	1/2" e 3/4"	E002800036	
			1"	E002800047	

CONECTOR PARA POLIWETZEL® - PRATA**SEM ROSCA INTERNA**

	DESCRIÇÃO	*BITOLA	CÓDIGO	QT. MÚTIPLA
	CONECTOR PARA POLIWETZEL SEM ROSCA INTERNA	1/2"	E001700020	40
		3/4"	E001700030	30
		1"	E001700040	20
		1.1/4"	E001700050	20
		1.1/2"	E001700060	20
		2"	E001700070	20

*O conector possui sua bitola correspondente a bitola do eletroduto e conseqüentemente também da caixa, porém em algumas bitolas as caixas são compartilhadas conforme ilustrado nas páginas 7 e 8.



TAMPAS

CEGA - MODULAR - MONOBLOCO

ALUMÍNIO PRATA



DISPONIBILIDADE SOB CONSULTA

CONHEÇA MAIS SOBRE

- DISPONÍVEL NAS BITOLAS 1,2", 3/4" E 1";
- ACOMPANHA PARAFUSOS ORGANOMETÁLICOS;
- O MODELO DE TAMPA MODULAR É COMPATÍVEL COM A LINHA INDUSTRIE.

LINHA INDUSTRIE



TAMPAS PRATA





TAMPAS CEGAS - PRATA

	DESCRIÇÃO	BITOLA	CÓDIGO	QT. MÚTIPLA
	CEGA	1/2" e 3/4"	E011130012	36
		1"	E011130032	

TAMPAS CEGAS ESTAMPADA - PRATA

	DESCRIÇÃO	BITOLA	CÓDIGO	QT. MÚTIPLA
	CEGA ESTAMPADA	1/2" e 3/4"	E011120013	50

TAMPAS PARA MECANISMOS MODULARES - PRATA

	DESCRIÇÃO	BITOLA	CÓDIGO	QT. MÚTIPLA
	PARA UM MÓDULO VERTICAL	1/2" e 3/4"	E011030522	12
	PARA UM MÓDULO HORIZONTAL	1"	E011030692	12
	PARA DOIS MÓDULOS HORIZONTAIS	1"	E011030702	12
	PARA TRÊS MÓDULOS HORIZONTAIS	1/2" e 3/4"	E011030532	12
		1"	E011030722	

TAMPAS PARA MECANISMOS MODULARES | TOMADAS RJ - PRATA

	DESCRIÇÃO	BITOLA	CÓDIGO	QT. MÚTIPLA
	PARA UMA TOMADA RJ 45	1/2" e 3/4"	E011030523	12
		1"	E011030693	
	PARA DUAS TOMADAS RJ 45	1/2" e 3/4"	E011030533	12
		1"	E011030703	
	COM UMA TOMADA RJ 45	1/2" e 3/4"	E011030525	12
		1"	E011030695	
	COM DUAS TOMADAS RJ 45	1/2" e 3/4"	E011030535	12
		1"	E011030705	

LINHA INDUSTRIE

MECANISMOS MODULARES

MÓDULOS WETZEL
ESPECIALMENTE DESENVOLVIDOS PARA AS
TAMPAS MODULARES.

Disponível na página 45



TAMPAS PARA MECANISMOS MONOBLOCOS - PRATA

	DESCRIÇÃO	BITOLA	CÓDIGO	QT. MÚTIPLA
	PARA DUAS TOMADAS HEXAGONAIS HORIZONTAIS SEPARADAS	1/2" e 3/4"	E011030362	36
	PARA DUAS TOMADAS REDONDAS	1"	E011030422	36
	PARA UM INTERRUPTOR VERTICAL	1/2" e 3/4"	E011030122	36
		1"	E011030282	
	PARA DOIS INTERRUPTORES HORIZONTAIS JUNTOS	1/2" e 3/4"	E011030132	36
		1"	E011030292	
	PARA TRÊS INTERRUPTORES HORIZONTAIS JUNTOS	1/2" e 3/4"	E011030142	36
		1"	E011030302	
	PARA DOIS INTERRUPTORES HORIZONTAIS SEPARADOS	1/2" e 3/4"	E011030152	36
		1"	E011030312	
	PARA UMA TOMADA REDONDA	1/2" e 3/4"	E011030162	36
		1"	E011030322	
	PARA UMA TOMADA HEXAGONAL VERTICAL	1/2" e 3/4"	E011032814	36
		1"	E011032815	

TAMPAS PARA TOMADAS RJ - PRATA

	DESCRIÇÃO	BITOLA	CÓDIGO	QT. MÚTIPLA
	PARA UMA TOMADA RJ SEM MOLDURA	1/2" e 3/4"	E011032502	36
		1"	E011032712	
	PARA DUAS TOMADAS RJ SEM MOLDURA	1/2" e 3/4"	E011032802	36
		1"	E011032602	
	PARA UMA TOMADA RJ COM MOLDURA	1/2" e 3/4"	E011032503	36
		1"	E011032713	
	PARA DUAS TOMADAS RJ COM MOLDURAS	1/2" e 3/4"	E011032803	36
		1"	E011032603	

POLIWETZEL[®]

ALUMÍNIO COM PINTURA EXTERNA

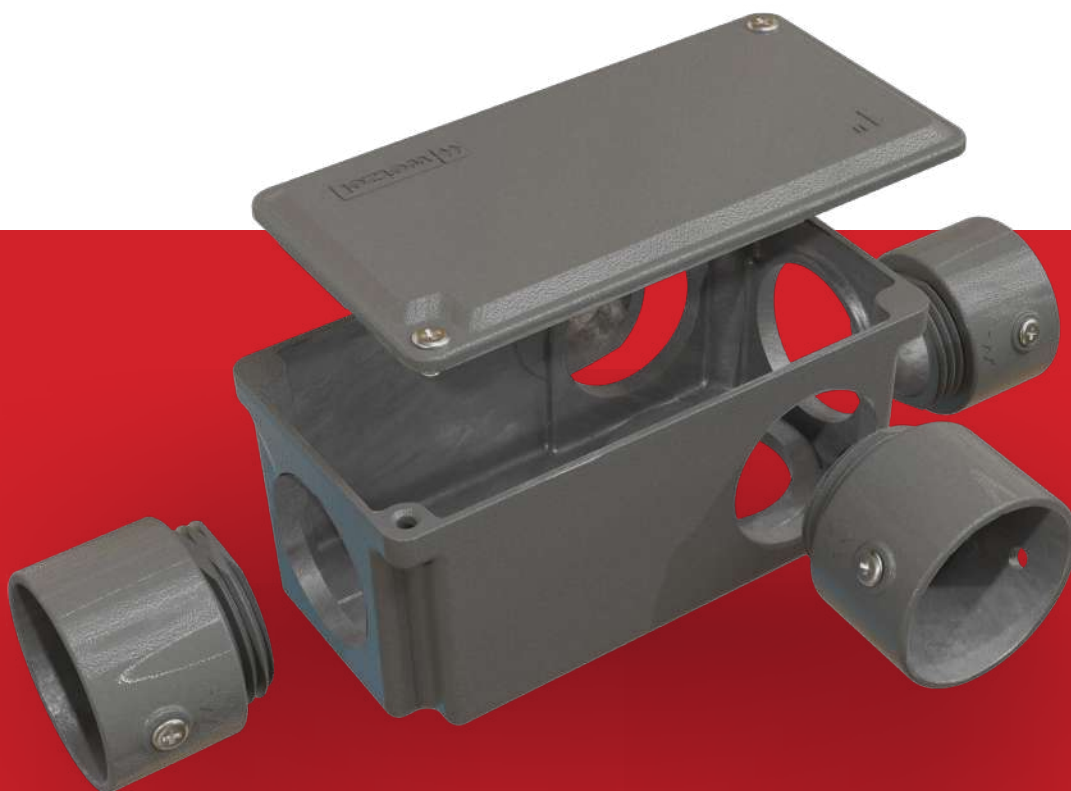

CONHEÇA MAIS SOBRE

- DISPONÍVEL NAS BITOLAS 1,2", 3/4" E 1";
- MODELOS L (LPW) E X (XPW);
- POSSUI PONTO DE ATERRAMENTO NBR 15701.



L (LPW)



X (XPW)





ALTURA DIFERENCIADA NA BITOLA 3/4"

PRATICIDADE NA INSTALAÇÃO E NA PASSAGEM DOS CABOS, QUE EVITA O ESMAGAMENTO E REDUZ RISCOS DE CURTOS CIRCUITOS ELÉTRICOS









CAIXA DE DERIVAÇÃO MÚLTIPLA POLIWETZEL® - COM PINTURA EXTERNA

SEM TAMPA

	DESCRIÇÃO	MODELO	BITOLA	CÓDIGO	QT. MÚLTIPLA	
	CORPO	L	1/2" e 3/4"	E002310031	12	
		X	1"	E002310041		
	CORPO		L	1/2" e 3/4"		E002410031
		X	1"	E002410041		
	CORPO E 2 TAMPÕES		L	1/2" e 3/4"	E002300031	12
		X	1"	E002300041		
	CORPO E 2 TAMPÕES		L	1/2" e 3/4"	E002400031	
		X	1"	E002400041		

COM TAMPA CEGA

	DESCRIÇÃO	MODELO	BITOLA	CÓDIGO	QT. MÚLTIPLA		
	CORPO COM TAMPA, 2 PARAFUSOS E 2 TAMPÕES	L	1/2" e 3/4"	E002300030	12		
			1"	E002300040			
				1.1/4" e 1.1/2"	E002300050	4	
				2"	E002300070		
				2.1/2" e 3"	E002300080		1
		4"	E002300090				
		CORPO COM TAMPA, 2 PARAFUSOS E 2 TAMPÕES	X	1/2" e 3/4"	E002400030	12	
				1"	E002400040		
					1.1/4" e 1.1/2"	E002400050	4
					2"	E002400070	
	2.1/2" e 3"				E002400080	1	
				4"	E002400090		

COM TAMPA MODULAR

	DESCRIÇÃO	MODELO	BITOLA	CÓDIGO	QT. MÚLTIPLA
	CORPO COM TAMPA MODULAR 1 POSTO, 2 PARAFUSOS E 2 TAMPÕES	L	1/2" e 3/4"	E002300035	12
			1"	E002300045	
		X	1/2" e 3/4"	E002400035	
			1"	E002400045	
	CORPO COM TAMPA MODULAR 2 POSTOS, 2 PARAFUSOS E 2 TAMPÕES	L	1"	E002300046	12
		X	1"	E002400046	
	CORPO COM TAMPA MODULAR 3 POSTOS, 2 PARAFUSOS E 2 TAMPÕES	L	1/2" e 3/4"	E002300036	12
			1"	E002300047	
		X	1/2" e 3/4"	E002400036	
			1"	E002400047	

POLIWETZEL® COM PINTURA EXTERNA

CONECTOR PARA POLIWETZEL® - COM PINTURA EXTERNA

SEM ROSCA INTERNA

	DESCRIÇÃO	*BITOLA	CÓDIGO	QT. MÚTIPLA
	CONECTOR PARA POLIWETZEL SEM ROSCA INTERNA	1/2"	E001130020	40
		3/4"	E001130030	30
		1"	E001130040	20
		1.1/4"	E001130050	20
		1.1/2"	E001130060	20
		2"	E001130070	20
		2.1/2"	E001130080	4
		3"	E001130090	4
		4"	E001130110	4

COM ROSCA INTERNA (SOB CONSULTA)

	DESCRIÇÃO	*BITOLA	CÓDIGO	QT. MÚTIPLA
	CONECTOR PARA POLIWETZEL COM ROSCA INTERNA	1/2"	E001140020	40
		3/4"	E001140030	30
		1"	E001140040	20

*O conector possui sua bitola correspondente a bitola do eletroduto e conseqüentemente também da caixa, porém em algumas bitolas as caixas são compartilhadas conforme ilustrado nas páginas 7 e 8.

TAMPAS

CEGA - MODULAR - MONOBLOCO

ALUMÍNIO COM PINTURA

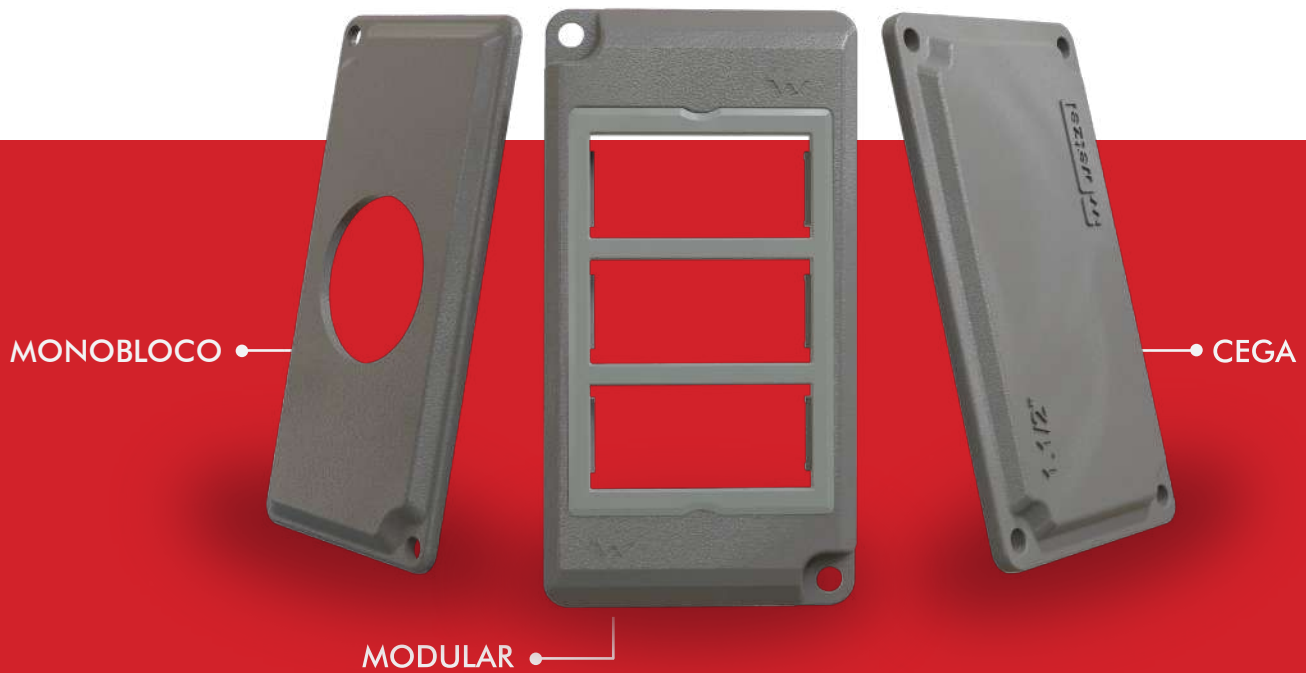

CONHEÇA MAIS SOBRE

- DISPONÍVEL NAS BITOLAS 1,2", 3/4" E 1";
- ACOMPANHA PARAFUSOS ORGANOMETÁLICOS;
- O MODELO DE TAMPA MODULAR É COMPATÍVEL COM A LINHA INDUSTRIE.

LINHA INDUSTRIE



TAMPAS COM PINTURA





TAMPAS CEGAS - COM PINTURA

	DESCRIÇÃO	BITOLA	CÓDIGO	QT. MÚTIPLA
 1/2" e 3/4" 1"	CEGA	1/2" e 3/4"	E011100012	36
		1"	E011100032	



TAMPAS CEGAS ESTAMPADAS - COM PINTURA

	DESCRIÇÃO	BITOLA	CÓDIGO	QT. MÚTIPLA
 1/2" e 3/4"	CEGA ESTAMPADA	1/2" e 3/4"	E011100013	50

TAMPAS PARA MECANISMOS MODULARES - COM PINTURA

	DESCRIÇÃO	BITOLA	CÓDIGO	QT. MÚTIPLA
 1/2" e 3/4"	PARA UM MÓDULO VERTICAL	1/2" e 3/4"	E011000522	12
 1"	PARA UM MÓDULO HORIZONTAL	1"	E011000692	12
 1"	PARA DOIS MÓDULOS HORIZONTAIS	1"	E011000702	12
 1/2" e 3/4" 1"	PARA TRÊS MÓDULOS HORIZONTAIS	1/2" e 3/4"	E011000532	12
		1"	E011000722	

TAMPAS PARA MECANISMOS MODULARES | TOMADAS RJ - COM PINTURA

	DESCRIÇÃO	BITOLA	CÓDIGO	QT. MÚTIPLA
 1/2" e 3/4" 1"	PARA UMA TOMADA RJ 45	1/2" e 3/4"	E011000523	12
		1"	E011000693	
 1/2" e 3/4" 1"	PARA DUAS TOMADAS RJ 45	1/2" e 3/4"	E011000533	12
		1"	E011000703	
 1/2" e 3/4" 1"	COM UMA TOMADA RJ 45	1/2" e 3/4"	E011000525	12
		1"	E011000695	
 1/2" e 3/4" 1"	COM DUAS TOMADAS RJ 45	1/2" e 3/4"	E011000535	12
		1"	E011000705	

LINHA INDUSTRIE

MECANISMOS MODULARES

MÓDULOS WETZEL
ESPECIALMENTE DESENVOLVIDOS PARA AS
TAMPAS MODULARES.

Disponível na página 45



TAMPAS PARA MECANISMOS MONOBLOCOS - COM PINTURA

	DESCRIÇÃO	BITOLA	CÓDIGO	QT. MÚTIPLA
	PARA DUAS TOMADAS HEXAGONAIS HORIZONTAIS SEPARADAS	1/2" e 3/4"	E011000362	36
	PARA UM INTERRUPTOR VERTICAL	1/2" e 3/4"	E011000122	36
		1"	E011000282	
	PARA DOIS INTERRUPTORES HORIZONTAIS JUNTOS	1/2" e 3/4"	E011000132	36
		1"	E011000292	
	PARA TRÊS INTERRUPTORES HORIZONTAIS JUNTOS	1/2" e 3/4"	E011000142	36
		1"	E011000302	
	PARA DOIS INTERRUPTORES HORIZONTAIS SEPARADOS	1/2" e 3/4"	E011000152	36
		1"	E011000312	
	PARA UMA TOMADA REDONDA	1/2" e 3/4"	E011000162	36
		1"	E011000322	
	PARA UMA TOMADA HEXAGONAL VERTICAL	1/2" e 3/4"	E011002814	36
		1"	E011002815	

TAMPAS PARA TOMADAS RJ - COM PINTURA



	DESCRIÇÃO	BITOLA	CÓDIGO	QT. MÚTIPLA
	PARA UMA TOMADA RJ SEM MOLDURA	1/2" e 3/4"	E011002502	36
		1"	E011002712	
	PARA DUAS TOMADAS RJ SEM MOLDURA	1/2" e 3/4"	E011002802	36
		1"	E011002602	
	PARA UMA TOMADA RJ COM MOLDURA	1/2" e 3/4"	E011002503	36
		1"	E011002713	
	PARA DUAS TOMADAS RJ COM MOLDURAS	1/2" e 3/4"	E011002803	36
		1"	E011002603	

ACESSÓRIOS PARA
POLI*WETZEL*****



ACESSÓRIOS RJ

	DESCRIÇÃO	CÓDIGO	COR	QT. MÚLTIPLA
	TAMPA CEGA DE PVC CINZA PARA TOMADA RJ	E073050004	CINZA	100
	TAMPA CEGA DE PVC BRANCA PARA TOMADA RJ	E073050005	BRANCO	100
	MOLDURA DE PVC CINZA PARA TOMADA RJ	E073050002	CINZA	100
	MOLDURA DE PVC BRANCA PARA TOMADA RJ	E073050003	BRANCO	100

ACESSÓRIOS RJ - PACOTE

	DESCRIÇÃO	CÓDIGO	COR	QT. MÚLTIPLA
	PACOTE TAMPA CEGA DE PVC CINZA PARA TOMADA RJ 10 PEÇAS	E073050024	CINZA	10
	PACOTE TAMPA CEGA DE PVC BRANCA PARA TOMADA RJ 10 PEÇAS	E073050025	BRANCO	10
	PACOTE MOLDURA DE PVC CINZA PARA TOMADA RJ 10 PEÇAS	E073050022	CINZA	10
	PACOTE MOLDURA DE PVC BRANCA PARA TOMADA RJ 10 PEÇAS	E073050023	BRANCO	10

TAMPÃO PARA CAIXA DE DERIVAÇÃO

	DESCRIÇÃO	BITOLA	CÓDIGO	QT. MÚLTIPLA
	TAMPÃO DE PVC PARA POLIWETZEL	1/2" e 3/4"	E060284002	100
		1"	E060284003	100
		1.1/4" e 1.1/2"	E060284004	40
		2"	E060284005	40
		2.1/2" e 3"	E060284006	20
		4"	E060284008	20

TAMPÃO PARA CAIXA DE DERIVAÇÃO - PACOTE

	DESCRIÇÃO	BITOLA	CÓDIGO	QT. MÚLTIPLA
	PACOTE TAMPÃO DE PVC PARA POLIWETZEL 10 PEÇAS	1/2" e 3/4"	E060284022	10
		1"	E060284023	10
		1.1/4" e 1.1/2"	E060284024	10
		2"	E060284025	10
		2.1/2" e 3"	E060284026	10
		4"	E060284028	10

JUNTA DE VEDAÇÃO PVC

	DESCRIÇÃO	BITOLA	CÓDIGO	QT. MÚLTIPLA
	JUNTA DE VEDAÇÃO PVC PARA TAMPA	1/2" e 3/4"	E060141001	12
		1"	E060141007	12
		1.1/4" e 1.1/2"	E060141009	12
		2"	E060141010	12

JUNTA DE VEDAÇÃO POLICLOROPRENO

	DESCRIÇÃO	BITOLA	CÓDIGO	QT. MÚLTIPLA
	JUNTA DE VEDAÇÃO POLICLOROPRENO PARA TAMPA	1/2" e 3/4"	E060141101	12
		1"	E060141103	12
		1.1/4" e 1.1/2"	E060141105	12
		2"	E060141106	12

ANEL DE VEDAÇÃO

	DESCRIÇÃO	BITOLA	CÓDIGO	QT. MÚLTIPLA
	ANEL DE VEDAÇÃO EM EPDM PARA CONEXÃO	1/2"	E060140112	12
		3/4"	E060140113	12
		1"	E060140114	12
	ANEL DE VEDAÇÃO EM TPE PARA CONEXÃO	1.1/4"	E060140115	12
		1.1/2"	E060140116	12
		2"	E060140117	12

KIT DE VEDAÇÃO PARA CAIXA DE DERIVAÇÃO (SOB CONSULTA)

DESCRIÇÃO	BITOLA	CÓDIGO	QT. MÚLTIPLA
KIT VEDAÇÃO PARA POLIWETZEL	1/2"	E002900020	12
	3/4"	E002900030	12
	1"	E002900040	12



O KIT ACOMPANHA:

- A - 1 JUNTA DE VEDAÇÃO (TAMPA/CAIXA)
- B - 3 TAMPÕES
- C - 3 ANÉIS DE VEDAÇÃO (CONECTOR/CAIXA)
- D - 3 ANÉIS DE VEDAÇÃO (ELETRODUTO/CONECTOR)
- E - 1 MANUAL DE INSTRUÇÃO

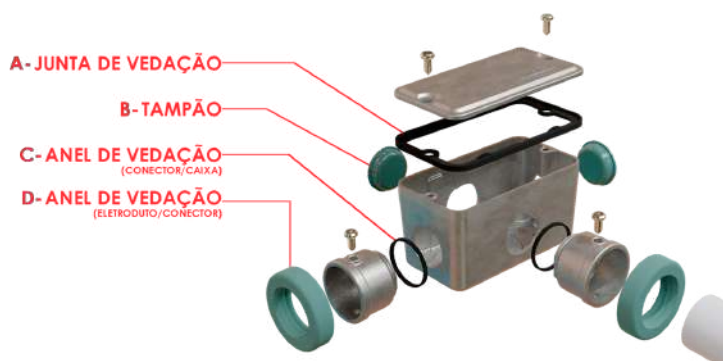

LINHA INDUSTRIE

MECANISMOS MODULARES



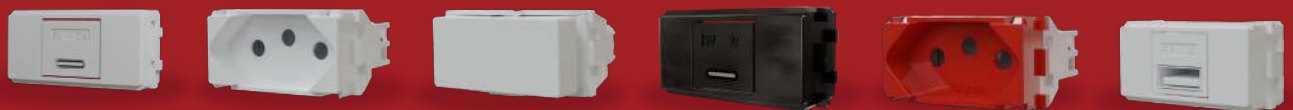

CONHEÇA OS COMBOS

- COMPATÍVEL COM AS TAMPAS MODULARES **WETZEL**;
- DESENVOLVIDOS PARA INSTALAÇÕES ELÉTRICAS INDUSTRIAIS DE BAIXA TENSÃO.



LINHA INDUSTRIE - MECANISMOS MODULARES

LINHA INDUSTRIE | MECANISMOS MODULARES

	DESCRIÇÃO	BITOLA	CÓDIGO	QT. MÚLTIPLA
	MÓDULO CAMPAINHA CIGARRA BIVOLT	E011100180	BRANCO	10
	MÓDULO CARREGADOR USB A	E011100140	BRANCO	10
	MÓDULO CARREGADOR USB C	E011100250	BRANCO	10
	MÓDULO INTERRUPTOR PARALELO 10A-250V	E011100125	BRANCO	25
	MÓDULO INTERRUPTOR SIMPLES 10A-250V	E011100115	BRANCO	25
	MÓDULO CEGO C/ 2 PÇS	E011100130	BRANCO	25
	MOLDURA RJ45 C/ 2 PÇS	E011100185	BRANCO	25
	MÓDULO SAÍDA FIO C/ 2 PÇS	E011100165	BRANCO	25
	MÓDULO PULSADOR CAMPAINHA 10A-250V	E011100170	BRANCO	10
	MÓDULO PULSADOR CAMPAINHA UNIVERSAL 10A-250V	E011100160	BRANCO	10
	MÓDULO TOMADA 2P+T 10A-250V	E011100110	BRANCO	25
	MÓDULO TOMADA 2P+T 10A-250V	E011100150	VERMELHO	25
	MÓDULO TOMADA 2P+T 20A-250V	E011100120	BRANCO	25
	MÓDULO TOMADA 2P+T 20A-250V	E011100175	VERMELHO	25
	MÓDULO TOMADA ANTENA TV	E011100135	BRANCO	25
	MÓDULO TOMADA RJ11 2 FIOS	E011100145	BRANCO	25
	MÓDULO TOMADA RJ45 CAT 5E	E011100155	BRANCO	25
	MÓDULO TOMADA RJ45 CAT 6E	E011100205	BRANCO	25

LINHA INDUSTRIE | MECANISMOS MODULARES - All Black

	DESCRIÇÃO	CÓDIGO	COR	QT. MÚLTIPLA
	MÓDULO CARREGADOR USB A	E011100245	PRETO	10
	MÓDULO CARREGADOR USB C	E011100255	PRETO	10
	MÓDULO INTERRUPTOR PARALELO 10A-250V	E011100225	PRETO	25
	MÓDULO INTERRUPTOR SIMPLES 10A-250V	E011100215	PRETO	25
	MÓDULO CEGO C/ 2 PÇS	E011100230	PRETO	25
	MÓDULO TOMADA 2P+T 10A-250V	E011100210	PRETO	25
	MÓDULO TOMADA 2P+T 20A-250V	E011100220	PRETO	25
	MOLDURA RJ45	E011100240	PRETO	25
	MÓDULO TOMADA RJ45 CAT 5E	E011100235	PRETO	25

POLIWETZEL® COM TAMPA DIMENSÕES (mm)

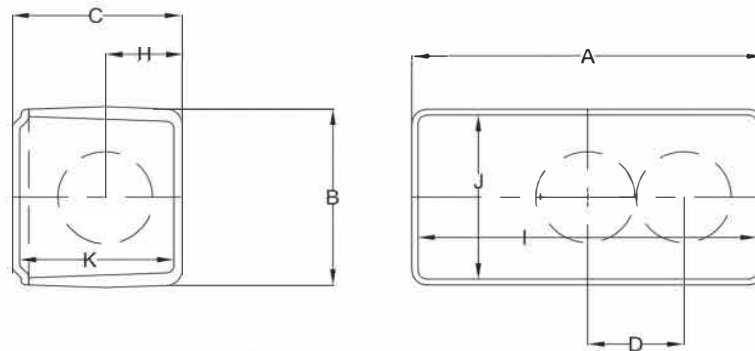

BITOLA	A	B	C	Modelo L		H	I	J	K
				D					
1/2" e 3/4"	92,5	50,5	52	19		20	89,5	47,5	49,5
1"	115	60	55	28,5		25	111,5	56,5	52
1.1/4" e 1.1/2"	143	80	75,5	31,5		32,5	139	76	71,5
2"	160	90	91,9	35		42,5	155	85	87
2.1/2" e 3"	200	115	115	42,5		54,5	195	110	108,5
4	240	145	139	40		64,5	235	140	131,5

POLIWETZEL® SEM TAMPA DIMENSÕES (mm)

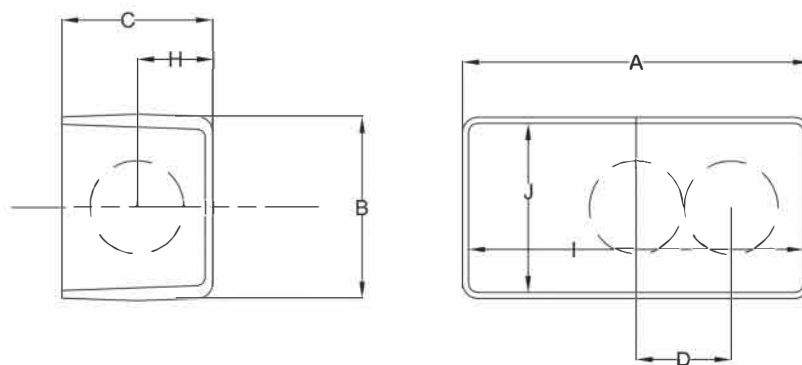

BITOLA	A	B	C	Modelo L		H	I	J
				D				
1/2" e 3/4"	92,5	50,5	48	19		20	89,5	47,5
1"	115	60	50	28,5		20	111,5	56,5

CONECTOR POLIWETZEL® SEM ROSCA INTERNA DIMENSÕES (mm)

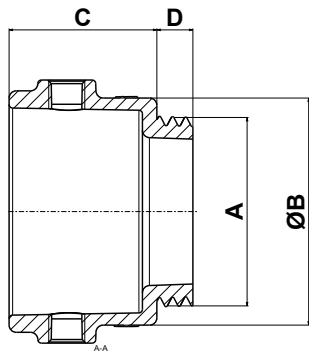

BITOLA	A	ØB	C	D
1/2"	R 1/2"	28	18	5
3/4"	R 3/4"	31,5	20,5	5
1"	R 1"	39,8	25	7
1.1/4"	R 1.1/4"	49	26	5,5
1.1/2"	R 1.1/2"	57	35	8
2"	R 2"	66	32	8
2.1/2"	R 2.1/2"	84,8	42,9	8
3"	R 3"	102	46,8	8
4"	R 4"	124,5	54,2	8

CONECTOR POLIWETZEL® COM ROSCA INTERNA DIMENSÕES (mm)

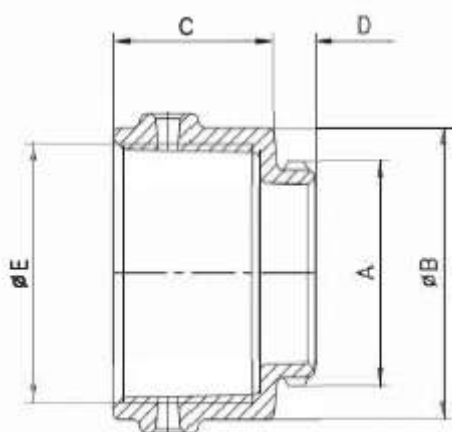

BITOLA	A	ØB	C	D	ØE
1/2"	R 1/2"	28	18	5,5	1/2"
3/4"	R 3/4"	31,8	20	6	3/4"
1"	R 1"	39	22,5	6	1"

TAMPÃO PARA CAIXA POLIWETZEL DIMENSÕES (mm)

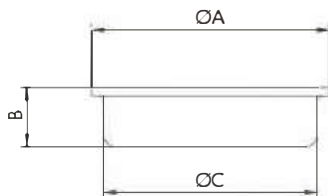

BITOLA	A	B	C
1/2" e 3/4"	28	7	25,2
1"	34,8	7	31,8
1.1/4" e 1.1/2"	52,1	7,7	46,5
2"	64	8,5	56
2.1/2" e 3"	83	10	72
4	126	11	111

JUNTA DE VEDAÇÃO (PVC) DIMENSÕES (mm)

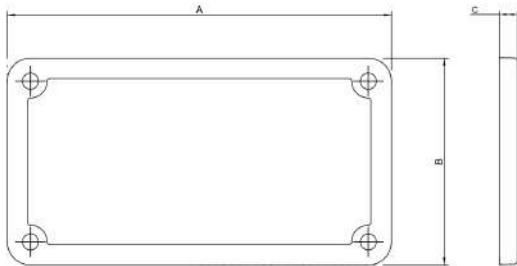

BITOLA	A	B	C
1/2" e 3/4"	95	53	3
1"	118	63	5
1.1/4" e 1.1/2"	144,5	83,5	3,5
2"	164,5	93,5	3,5

JUNTA DE VEDAÇÃO (POLICLOROPRENO) DIMENSÕES (mm)

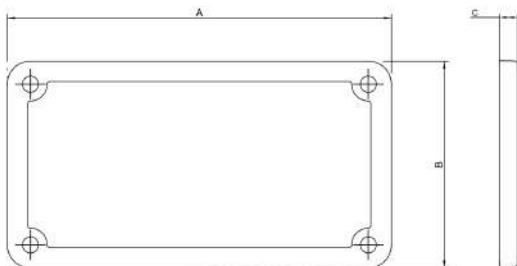

BITOLA	A	B	C
1/2" e 3/4"	95,5	53,5	4
1"	119,3	64,3	5,5
1.1/4" e 1.1/2"	144,3	84,2	6
2"	164,4	94,3	6

ANEL DE VEDAÇÃO DIMENSÕES (mm)

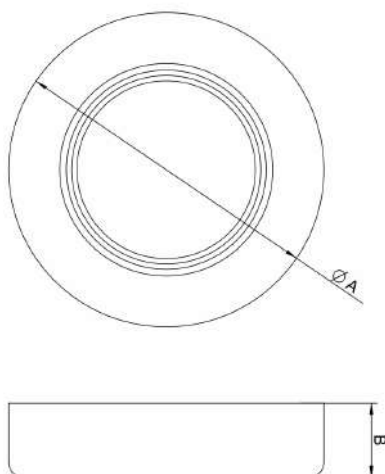

BITOLA	A	B
1/2"	36	8,1
3/4"	40	9,5
1"	49,2	10,5
1.1/4"	58	22,3
1.1/2"	64	21,8
2"	76	22,4

TAMPAS DIMENSÕES (mm)

TAMPA CEGA 1/2" E 3/4"

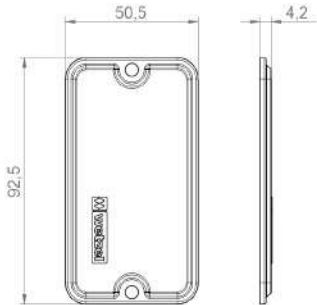

TAMPA CEGA 1"

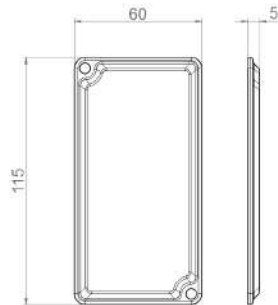

TAMPA P/ 1 INTERRUPTOR VERTICAL 1/2" E 3/4"

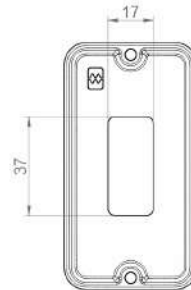

TAMPA P/ 1 INTERRUPTOR VERTICAL 1"

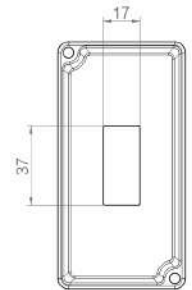

TAMPA P/ 2 INTERRUPTORES HORIZONTAIS 1/2" E 3/4"

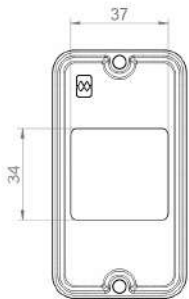

TAMPA P/ 2 INTERRUPTORES HORIZONTAIS 1"

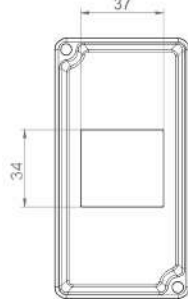

TAMPA P/ 3 INTERRUPTORES HORIZONTAIS 1/2" E 3/4"



TAMPA P/ 3 INTERRUPTORES HORIZONTAIS 1"

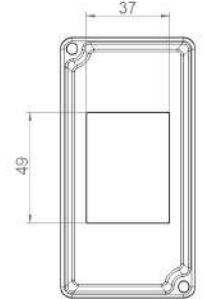

TAMPA P/ 2 INTERRUPTORES HORIZONTAIS SEPARADOS 1/2" E 3/4"

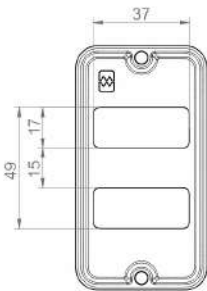

TAMPA P/ 2 INTERRUPTORES HORIZONTAIS SEPARADOS 1"

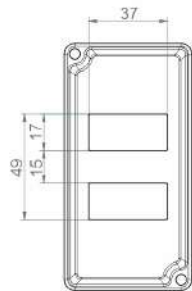

TAMPA P/ 1 TOMADA REDONDA 1/2" E 3/4"

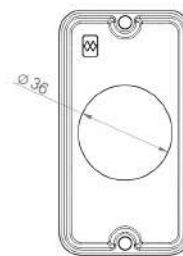

TAMPA P/ 1 TOMADA REDONDA 1"

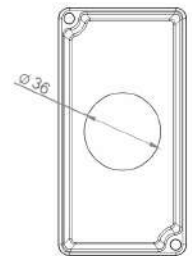

TAPA P/ 2 TOMADAS HEXAGONAIS HORIZONTAIS 1/2" E 3/4"

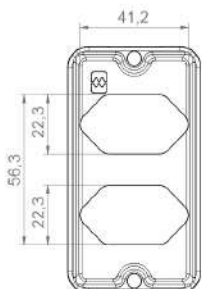



TAMPA P/ 1 TOMADA
HEXAGONAL VERTICAL
1/2" E 3/4"

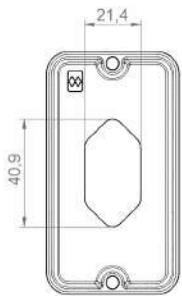

TAMPA P/ 1 TOMADA
HEXAGONAL VERTICAL
1"

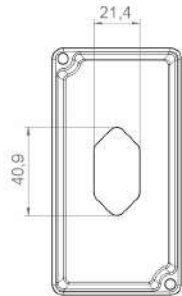

TAMPA P/ 1 RJ S/MOLDURA
1/2" E 3/4"

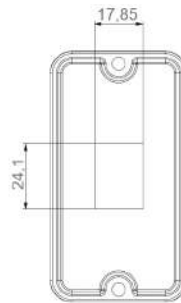

TAMPA P/ 1 RJ S/MOLDURA 1"

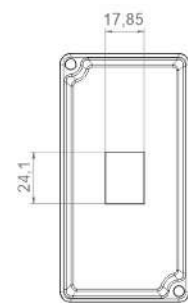

TAMPA P/ 2 RJ S/MOLDURA
1/2" E 3/4"

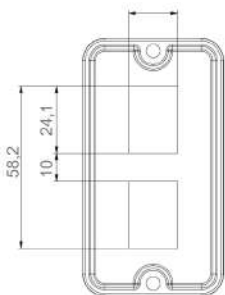

TAMPA P/ 2 RJ S/MOLDURA 1"

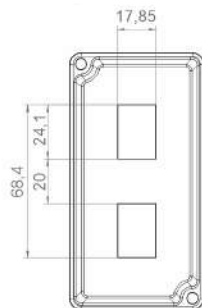

TAMPA C/ MOLDURA P/ 1
MÓDULO VERTICAL 1/2" E 3/4"

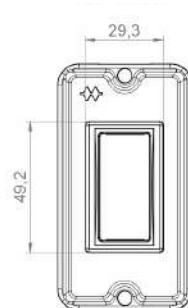

TAMPA C/ MOLDURA P/ 1
MÓDULO HORIZONTAL 1"

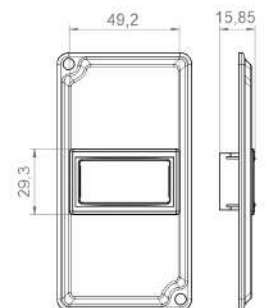

TAMPA C/ MOLDURA P/ 2
MÓDULOS HORIZONTAIS 1"

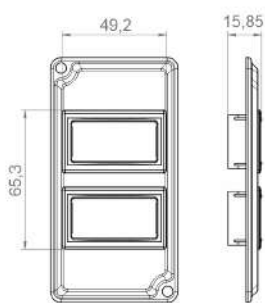

TAMPA C/ MOLDURA P/ 3
MÓDULOS HORIZONTAIS
1/2" E 3/4"

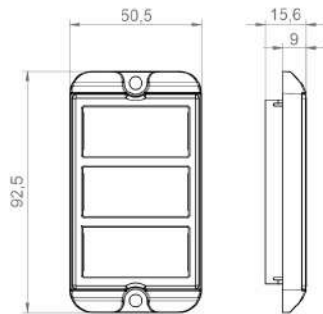

TAMPA C/ MOLDURA P/ 3
MÓDULOS HORIZONTAIS 1"

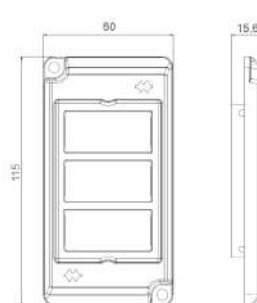

TAMPA + MOLDURA RJ

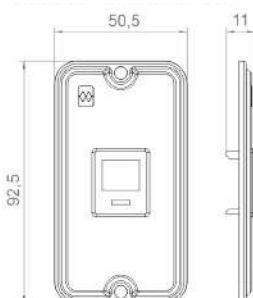

TAMPA P/ 2 MOLDURAS RJ

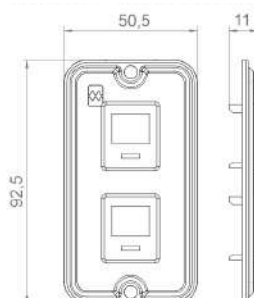

MOLDURA RJ

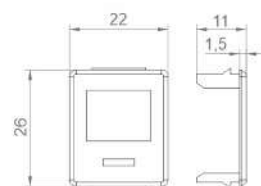

TAMPA P/ MOLDURA RJ



LINHA INDUSTRIE - MECANISMOS MODULARES

DIMENSÕES (mm)

MÓDULO CAMPAINHA
CIGARRA BIVOLT

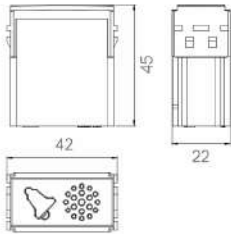

MÓDULO CARREGADOR
USB 5.0V 2.0A

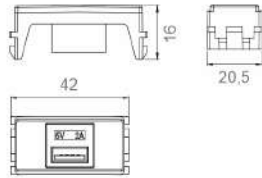

MÓDULO INTERRUPTOR
PARALELO 10A 250V



MÓDULO INTERRUPTOR
PARALELO 20A 250V

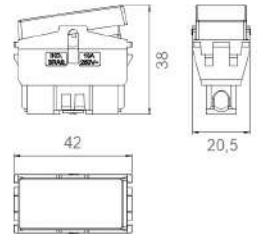

MÓDULO CEGO C/2 PÇS

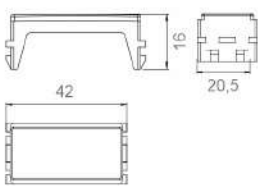

MÓDULO RJ45 C/2 PÇS

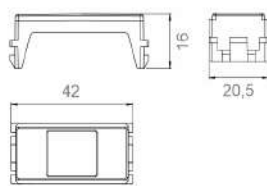

MÓDULO SAÍDA FIO C/2 PÇS

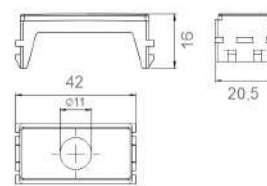

MÓDULO PULSADOR
CAMPAINHA 10A 250V

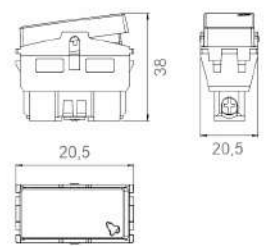

MÓDULO PULSADOR CAMPAINHA
UNIVERSAL 10A 250V

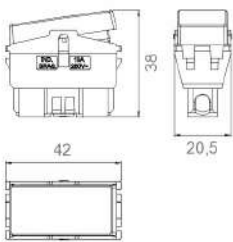

MÓDULO TOMADA
2P-T 10A 250V

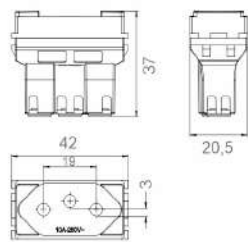

MÓDULO TOMADA
2P+T 10A 250V

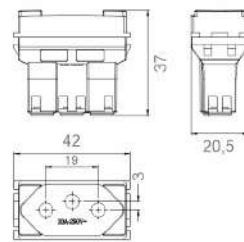

MÓDULO TOMADA
ANTENA TV

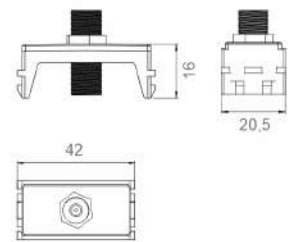

MÓDULO TOMADA
RJ11 2F

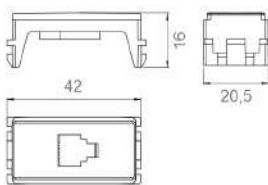

MÓDULO TOMADA
RJ45 CAT5E

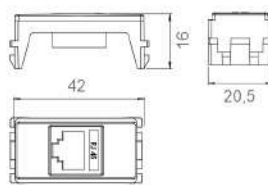

MECANISMO
MONOBLOCO

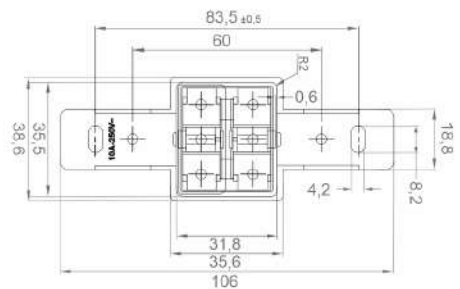



ALUMINIUM

WETZEL.COM.BR